

OutCam ROTATIVE

Caméra de surveillance

rotative extérieure

Outdoor rotative surveillance camera
Camera di sorveglianza rotante esterna
Cámara de vigilancia rotativa exterior



OutCam ROTATIVE

SV10061

FULL HD

Haute définition
1080 p



Détection et
suivi de
mouvement



Éclairage
spots







REC

Fonction
enregistrement



Champ
de vision

-  Notice d'utilisation et d'installation (p3)
-  Installation and user manual (p17)
-  Manuale d'installazione e uso (p31)
-  Instrucciones de uso e instalación (p45)

A- PRÉCAUTIONS D'UTILISATION

Ce manuel fait partie intégrante de votre produit. Ces instructions sont pour votre sécurité. Lisez-les attentivement avant utilisation et conservez-les pour une consultation ultérieure. Le bloc d'alimentation doit être installé dans un lieu sec. Vérifier que ce produit est utilisé uniquement pour l'usage auquel il est destiné.

 Cette notice peut être amenée à évoluer selon les mises à jour de l'application. Afin d'être sûr d'avoir la dernière version, nous vous conseillons de la télécharger sur notre site internet www.scs-sentinel.com ou sur l'application iSCS Sentinel : réglages / notice

B- DESCRIPTIF

Contenu du kit



Caméra avec antenne et câble d'alimentation intégrés



Adaptateur électrique



Notice



Visserie



Kit d'étanchéité

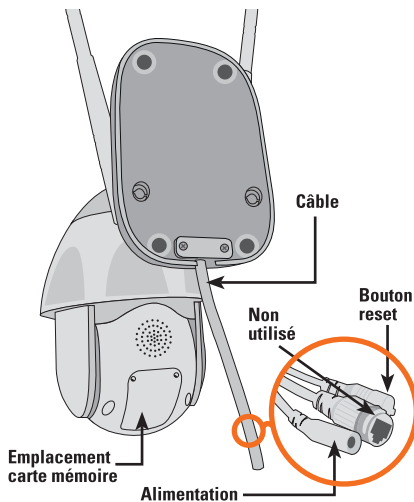
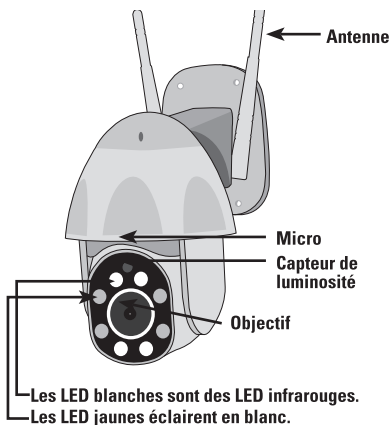

C- INSTALLATION

1. Fixer la caméra à l'aide de vis et chevilles appropriées à la nature du support (les vis et chevilles fournies conviennent pour des murs en matériau plein).
2. Attention à fixer solidement la caméra pour éviter toute chute.

Dévissez les 3 vis sur le dessus de votre caméra

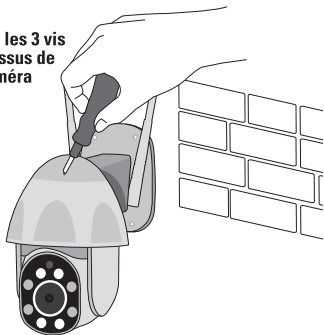

Fixez au mur

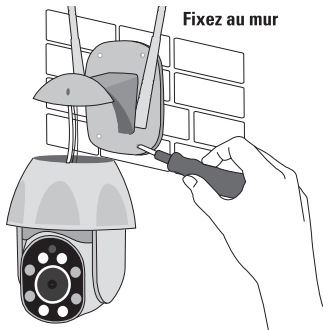

Revissez les 3 vis après avoir fixé la caméra au mur

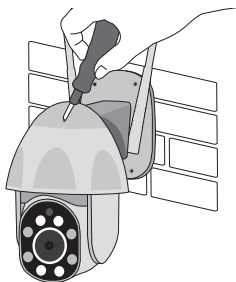

L'adaptateur doit être branché à l'intérieur



Vous pouvez insérer dans la caméra une carte mémoire au format micro SD (de 4Go à 128Go) pour stocker des séquences vidéo dans la caméra. **La carte micro SD est nécessaire pour accéder à l'historique des vidéos depuis l'application.**

Dévissez les deux vis du cache

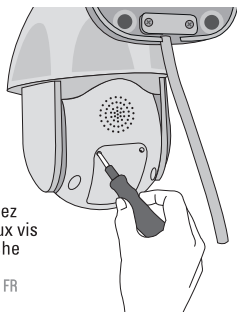

Insérez ici la carte micro SD, remettez le cache en place, revissez et redémarrez la caméra.

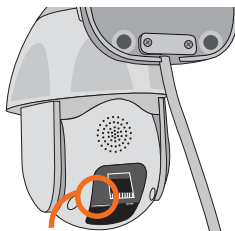

D- CONFIGURATION

Installation de l'application



ICS Sentinel

Pour télécharger l'application, connectez-vous sur l'App Store ou le Play Store de votre smartphone. Recherchez «ICS Sentinel», cliquez ensuite sur Installer.

1.



Lorsque le téléchargement est terminé, ouvrez l'application et cliquez sur créer mon compte.

2.



Renseignez votre adresse mail ainsi que votre mot de passe dans les cases correspondantes.

3.

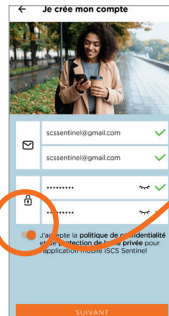

Appuyez sur suivant.



Veillez accepter la politique de confidentialité avant de cliquer sur suivant.

4.

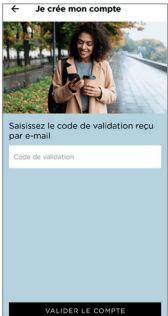

Renseignez votre code de validation reçu par mail. Puis validez le compte.

5.

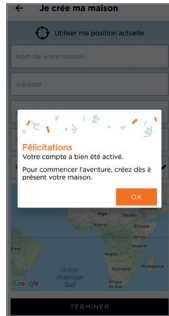

6.

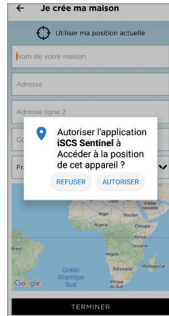

Appuyez sur **AUTORISER**.

7.

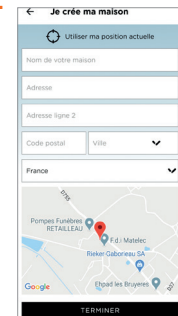

Renseignez toutes les informations demandées pour créer votre maison. Puis cliquez sur terminer.

Ajout de la caméra



WIFI

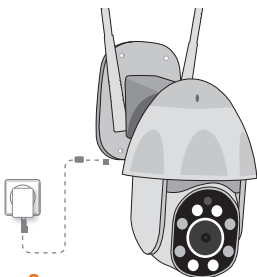

Branchez l'alimentation de la caméra et placez-la à proximité de votre routeur Wi-Fi.

Votre téléphone doit être connecté au même réseau Wi-Fi que votre caméra. Attendez l'annonce vocale.

1.



Appuyez sur **+** puis sur «**NOUVEL APPAREIL**» pour ajouter votre caméra.

2.



Renseignez votre clé Wi-Fi et flashez le QR Code de votre caméra ou entrez le code manuellement.



Le réseau doit être en 2.4 GHz pour fonctionner.



2.4 GHz

3.



Lorsque la caméra annonce «en attente de configuration», appuyez sur suivant. Si la caméra n'annonce rien, appuyez sur le bouton reset pendant 5s.

4.



5.

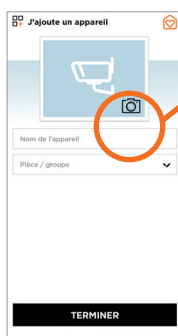

Renseignez un nom pour la caméra et la pièce dans laquelle elle se trouve.

Ajoutez une photo de profil à partir de l'appareil photo, de la galerie ou sélectionnez une image par défaut (visuel du produit ou dernière capture de mouvement.)

6.

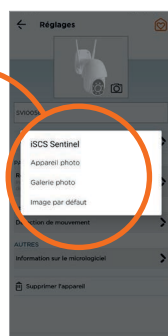



En cas d'échec lors de la connexion de l'appareil au Wi-Fi, une page d'erreur apparaît.

Résolution en cas d'échec

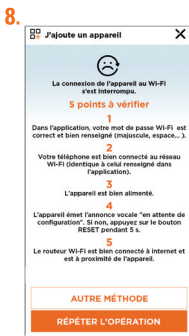

En cliquant sur «répéter l'opération» : vous revenez à la 2^{ème} étape.



Si «répéter l'opération» ne fonctionne pas, appuyez sur «autre méthode»

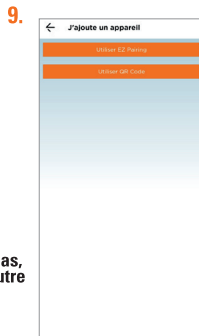

Vérifiez ces 5 points.

Cliquez sur «utiliser QR Code»

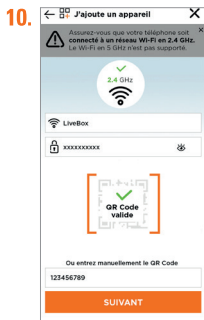

Vérifiez les informations et cliquez sur suivant.



Respectez ces 3 étapes en appuyant sur «afficher le QR Code».



Avez-vous entendu le signal sonore ?
Non : recommencer.
Oui : Etape validée



Le chargement s'effectue et les 3 étapes sont validées. Vous revenez ainsi à l'étape 5 et 6 pour changer la photo de profil.

Réglages de l'application



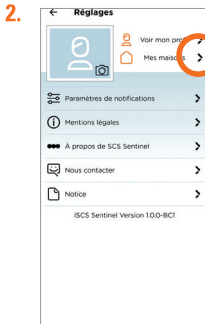

Appuyez sur  pour accéder aux réglages de l'application.

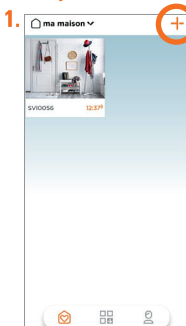

Voir mon profil :
Modifiez si vous le souhaitez vos informations personnelles.

Pour ajouter une maison



Cliquez sur 

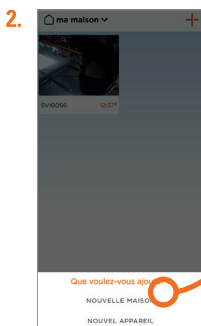

Créer une nouvelle maison.

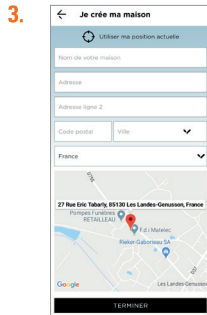

Renseignez les champs et appuyez sur «TERMINER».

Pour supprimer une maison



Appuyez sur 

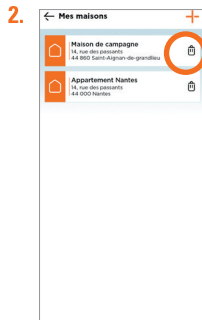

Appuyez sur  pour supprimer une maison.

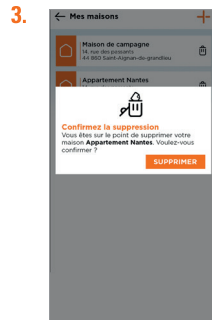

Pour modifier une maison



- 

Appuyez sur 
- 

Modifier l'adresse.
- 

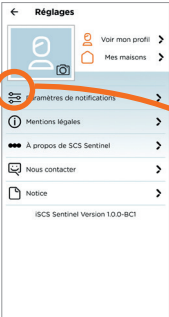
Paramètres de notifications

- 

Appuyez sur  pour accéder aux paramètres de notifications.
- 

Appuyez sur «Activer les notifications» pour activer la totalité des notifications. Sinon appuyez sur les notifications souhaitées.

Utilisation de l'application

- 

Activez l'écoute.



Appuyez pour parler.



Capturez la photo dans votre téléphone.



Activez le plein écran (basculer le téléphone).
Capturez la vidéo dans votre téléphone.

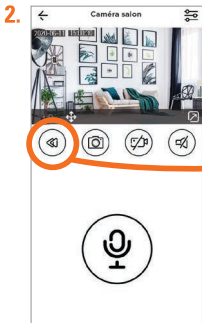

Visionnez ce qu'il s'est passé.

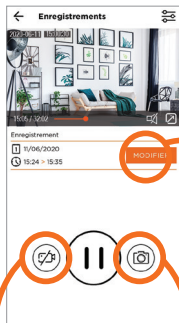

Choisissez la date et l'heure de l'évènement à visionner.

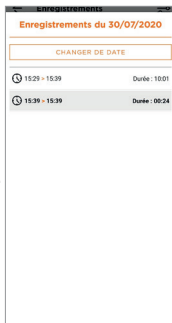

Cliquez sur «changer de date» et sur l'heure souhaité pour visionner ce qu'il s'est passé.

Enregistrez une vidéo

Enregistrez une photo

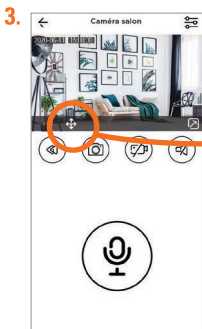

Appuyez sur  pour activer le joystick.

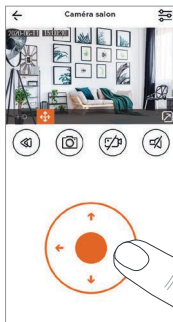

Le joystick permet de déplacer la vue de la caméra de haut en bas et de gauche à droite.

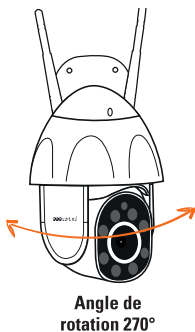
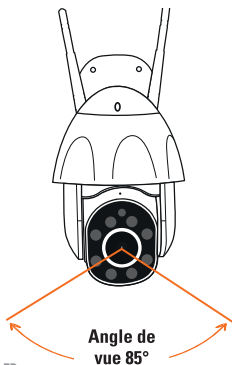

Un angle de vue de 85° et un angle de rotation de 270° permettent d'atteindre un champ de vision de 360°. Pour cela il suffit de faire tourner la caméra à l'aide des flèches depuis l'application.

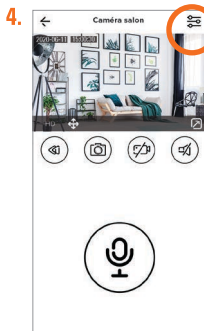

Appuyez sur  pour modifier les paramètres de la caméra.



Par défaut, la caméra apparaîtra dès l'ouverture de l'application dans la liste des favoris.

Appuyez sur  pour ajouter/supprimer la caméra des favoris.



Appuyez sur réglage de fonction de base.



Réglages de fonction de base

- Inversion d'image
- Surimpression
- Contrôle de la lumière >
Lumière ON si mouvement
- Suivi de mouvement

Sélectionnez «Inversion d'image» pour activer la rotation de l'image lorsque vous devez positionner votre caméra à l'envers.

Sélectionnez « surimpression » pour afficher la date et l'heure sur la vidéo.

Cliquez sur «Contrôle de la lumière» pour afficher les différentes possibilités de la vision nocturne.
« Lumière ON si mouvement » : la caméra éclaire la scène si une forme humaine est détectée
« Lumière OFF » : la caméra n'éclaire jamais la scène
« Lumière ON » : la caméra éclaire la scène en permanence

Sélectionnez «Suivi de mouvement» si vous souhaitez que la caméra suive le mouvement du visiteur en pivotant.

6. Suivi de mouvement

Si vous activez le «suivi de mouvement», votre caméra pivotera à chaque mouvement d'un visiteur présent dans son angle de vue.

Définir le champ de vision par défaut à surveiller (position de votre caméra).

Étape 1 - Définissez tout d'abord une zone à surveiller en orientant votre caméra grâce à l'application iSCS Sentinel. (joystick, page 10)

Étape 2 - Une fois la caméra orientée vers la zone à surveiller, activez le suivi de mouvement (page 11).

PRÊT - Votre caméra suit le mouvement du visiteur, une fois qu'il n'y a plus de mouvement votre caméra retourne à sa position choisie (étape 1).

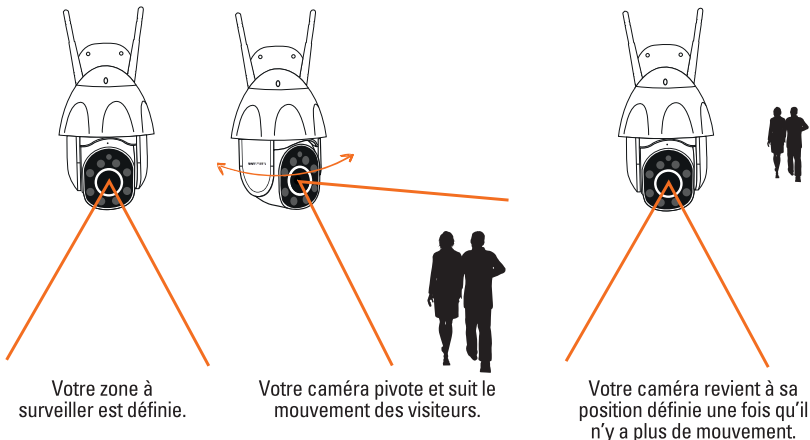

7. Visionnage des enregistrements de détection de mouvement

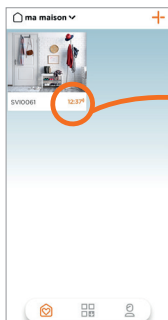

L'heure ne s'affichera pas si aucun mouvement n'est détecté.

Cliquez sur l'heure de l'enregistrement de la dernière détection de mouvement.

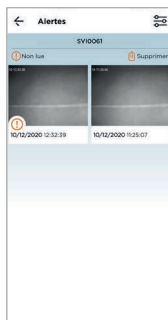

Cliquez sur la vidéo pour visionner la dernière détection de mouvement.

8.



Appuyez sur «Sensibilité» pour gérer le détecteur de mouvement. Plus la sensibilité est haute, plus la caméra détecte un mouvement.

Appuyez sur «détection de mouvement» pour programmer la détection de mouvement.

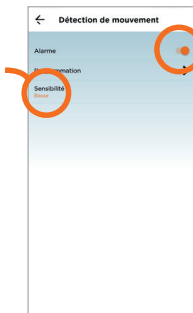

Sélectionnez «Alarme» si vous souhaitez être alerté d'un mouvement.

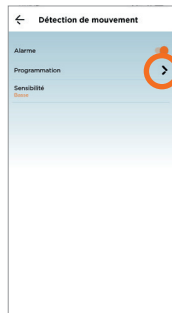

Appuyez sur «Programmation»

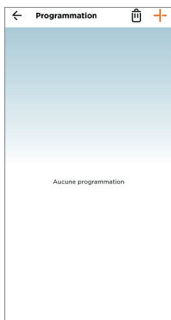

Appuyez sur 

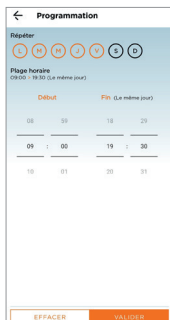

Sélectionnez les jours souhaités et la plage horaire des détections de mouvement puis «VALIDER»

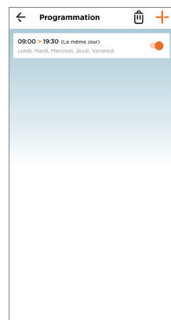

Votre programmation a bien été ajoutée.

Réglages carte SD (seulement si vous en avez une dans votre caméra)

1.



Appuyez sur «carte micro SD» pour accéder aux réglages.

2.

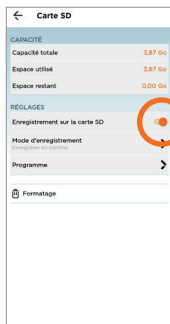

Appuyez sur «Enregistrement sur la carte micro SD» pour que les photos et vidéos soient automatiquement enregistrées sur la carte micro SD de votre caméra.

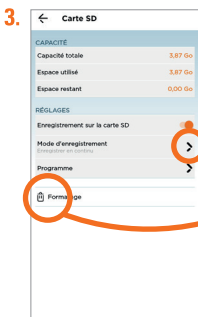

Appuyez sur «Mode d'enregistrement».

Appuyez sur «formatage» pour remettre à zéro votre carte micro SD.

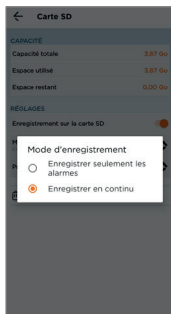

Choisissez ensuite d'enregistrer seulement les alarmes ou d'enregistrer en continu.

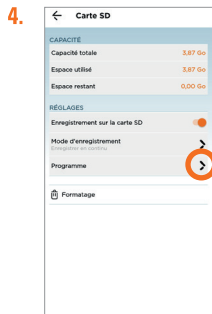

Appuyez sur «Programmer» pour programmer les périodes d'enregistrement sur la carte SD.

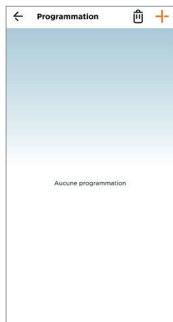

Appuyez sur +



Sélectionnez les jours souhaités et la plage horaire des enregistrements vidéos/photos puis «VALIDER».

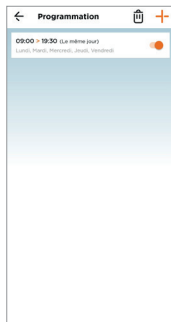

Votre programmation a bien été ajoutée.

Reset

Pour réinitialiser la caméra, maintenir le bouton appuyé durant 5 secondes. Cette opération supprimera l'appairage de la caméra à votre réseau Wi-Fi.

Pour totalement supprimer l'appareil il faudra le supprimer également dans l'application.

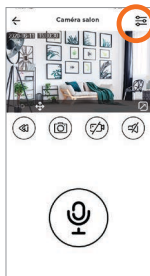
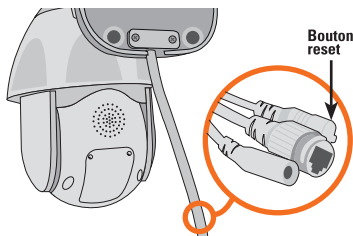

E- CARACTÉRISTIQUES TECHNIQUES

Caméra

Résolution	1080p
Portée Wi-Fi	30 m en champ libre
Compatibilité	iOS, Android
Détection de mouvement / Vision nocturne	Oui
Carte mémoire	Micro SD de 4 à 128 Go (non fournie)
Enregistrement vidéo	Oui (sur carte microSD)
Angle de vue horizontal	85°
Angle de vue vertical	45°
Angle de rotation horizontal	270°
Angle de rotation vertical	90°
Fréquence de fonctionnement	2412-2472 MHz
Puissance max. transmise	< 100 mW
Résistant aux intempéries	IP 65

Adaptateur

Alimentation

Entrée : 100-240V AC 50/60Hz 0,7A
Sortie : 12V DC 2A

F- ASSISTANCE TECHNIQUE

Aide au dépannage

Problème rencontré	Solutions
Si l'ajout de la caméra échoue	<ul style="list-style-type: none">- Vérifier que l'alimentation est bien branchée.- Vérifier que vous êtes bien connecté en Wi-Fi.- Lorsque vous tapez le mot de passe Wi-Fi, ne pas taper les espaces.- Vérifier que vous avez bien saisi le mot de passe Wi-Fi.- Vérifier que votre box est bien connectée à Internet.- Assurez-vous d'avoir un débit suffisant.- Vérifier que votre smartphone est sur le même réseau que celui renseigné dans l'application.- Vérifier que le réseau Wi-Fi sur lequel vous essayez de vous connecter est bien en 2.4GHz et non en 5GHz.- Faire l'appairage à moins de 3m de la box Wi-Fi.- Contacter votre fournisseur d'accès internet pour vérifier les paramètres de votre box (UPNP activé, filtrage des adresses MAC désactivé, SSID non masqué, DHCP activé, VPN ou Proxy désactivé).

Assistance téléphonique

En cas de besoin, vous pouvez prendre contact avec notre assistance technique au numéro ci-dessous. Notre équipe de techniciens, basée en France, assure un conseil avisé et personnalisé.



Hotline

0 892 350 490

Service 0,15 € / min
+ prix appel

Horaires hotline, voir sur le site internet : scs-sentinel.com

Avant de nous contacter :

- Préparez votre ticket de caisse ou votre facture d'achat ORIGINALE
- Indiquez-nous la référence de votre caméra

G- GARANTIE



Garantie 2 ans

Conservez soigneusement le code-barre ainsi que votre justificatif d'achat, il vous sera demandé pour faire jouer la garantie.

Il est impératif de garder une preuve d'achat durant toute la période de garantie.

Ne sont pas couverts par la garantie :

- Dommages matériels ou électriques résultant d'une mauvaise installation.
- Dommages résultant d'une utilisation impropre (utilisation différente de son origine) ou de modifications.
- Dommages résultant de l'utilisation et/ou installation de pièces ne provenant pas de celles prévues et incluses par SCS Sentinel.
- Dommages dus à un manque d'entretien ou un choc.
- Dommages dus aux intempéries telles que : grêle, foudre, vent violent, etc.
- Retours articles sans copie de facture ou justificatif d'achat.

H- AVERTISSEMENTS



Ne jetez pas les appareils hors d'usage avec les ordures ménagères. Les substances dangereuses qu'ils sont susceptibles de contenir peuvent nuire à la santé et à l'environnement. Utilisez les moyens de collectes sélectives mis à votre disposition par votre commune ou votre distributeur.



A- SAFETY INSTRUCTIONS

This manual is an important part of your product. These instructions are designed to ensure your safety. Please read them carefully before use and keep them in a safe place for future consultation. The power supply unit must be set up in a dry location. This product must only be used for its intended purpose.

 This manual may be amended as the application is updated. To ensure you have the latest version, we recommend you download it from our website www.scs-sentinel.com or from the app iSCS Sentinel : settings / manual.

B- DESCRIPTION

Kit content



Camera with integrated antenna and power supply cable



Electrical adaptor



Manual



Screw and bolt kit



Waterproofing kit

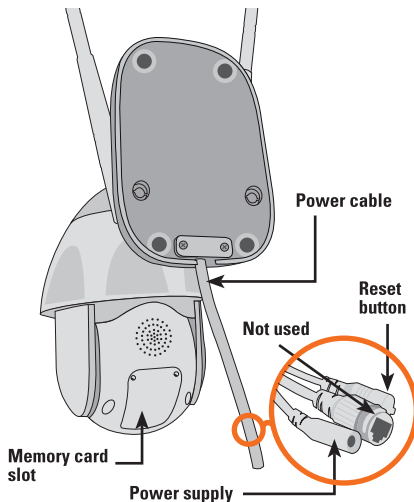
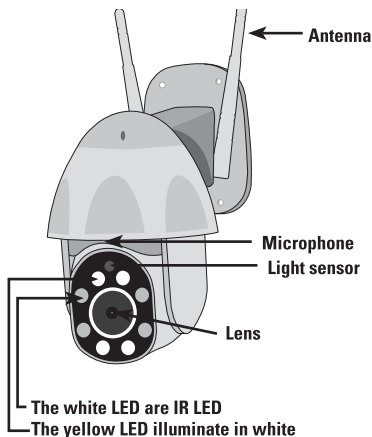

C- INSTALLATION

1. Attach the camera using screws and wall plugs adapted to the support (screws and wall plugs provided are for solid walls).
2. Make sure the camera is securely attached to prevent it from falling.

Unscrew the 3 screws on top of your camera

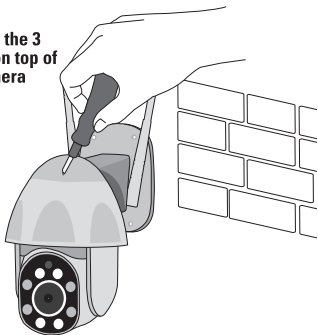

Attach to wall

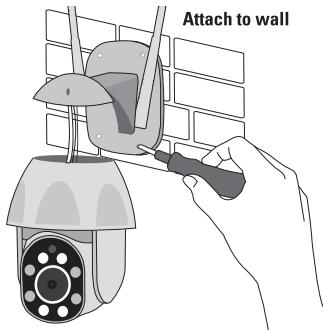

Screw back the 3 screws after fixing the camera to the wall

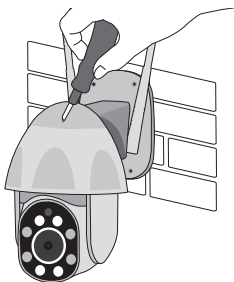

The adaptor must be plugged in inside.



You can insert a micro SD memory card (4 Gb-128 Gb) in the camera in order to store video sequences in the camera. **A micro SD card is required to access the video history from the app.**

Unscrew the two cover screws

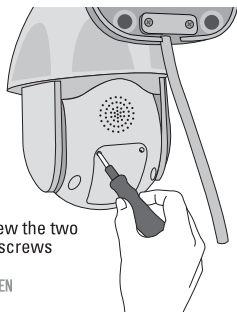

Insert here the micro SD card, put back the cover in place, rescrew and restart the camera.

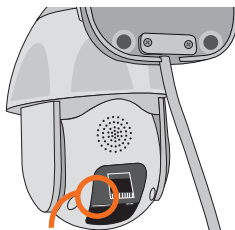

D- CONFIGURATION

Installing the app



iSCS Sentinel

To download the app, go on to the App Store or Play Store on your smartphone. Search for “iSCS Sentinel”, then click on install.

1.



Once the download is complete, open the app and click on register.

2.



Enter your email address and password in the relevant boxes.

3.



Please agree to the privacy policy before clicking next.

Click next.

4.



Enter the validation code you received by email. Then confirm the account.

5.

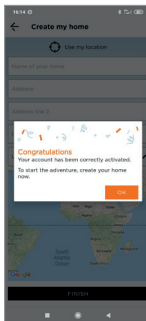

6.

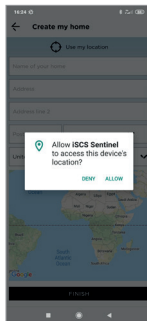

Click on ALLOW.

7.

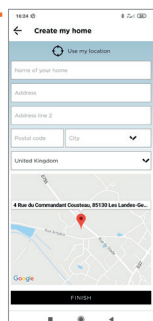

Enter all the information requested to create your home. Then click on finish.

Adding the camera



WIFI

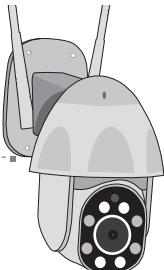

Plug in the camera's power cable and place it close to your wi-fi router. Your phone must be connected to the same wi-fi network as your camera. Wait for the voice command.

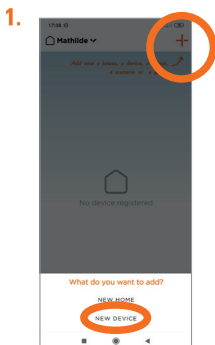

Click on "NEW DEVICE" to add your camera.

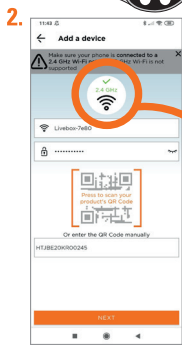

The network needs to be 2.4 GHz to work.

2.4 GHz



When the camera announces "awaiting setup", press next. If the camera makes no announcement, hold the Reset button down for 5 secs.

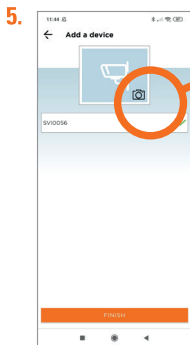
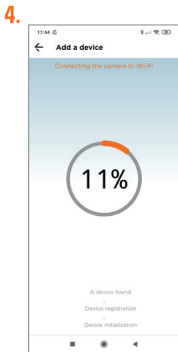

Enter a name for the camera and the room in which it is located.

Add a profil picture from your camera, the gallery or select a picture by default (product visual or last motion capture).

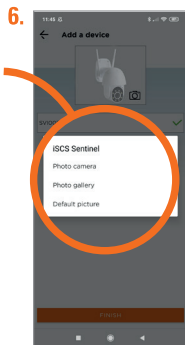



If the device fails to connect to wi-fi, an error page is displayed.

Troubleshooting

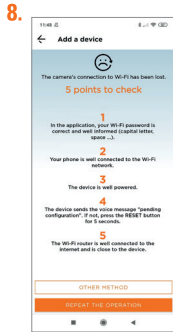
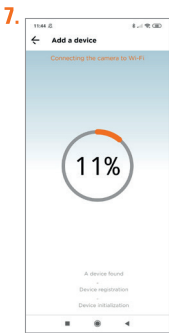

Check these five points.

Clicking on "repeat operation" takes you back to the second step.



If "repeat operation" does not work, click on "other method"



Click on «use QR Code»



Check the information and click Next.

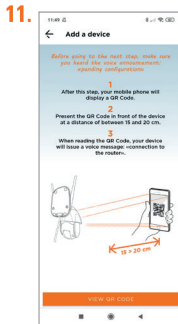

Follow these three steps, pressing "show QR code".



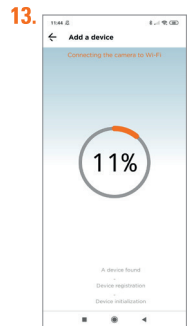

Did you hear the beep?
No: start again.
Yes: Step complete

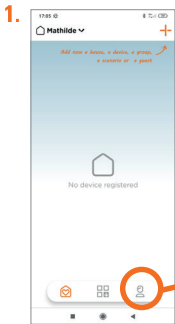

Loading begins and the three steps are completed. This will take you to step 5 and 6 for changing the profile photo.

Application settings



Click on  to go to the app settings.

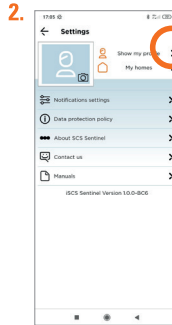

View my profile:
If you want to, you can edit your personal information.

To add a home

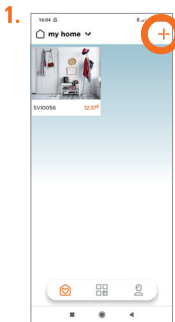

Click on .

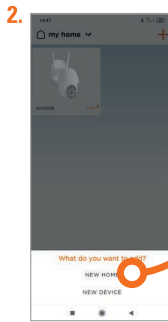

Create a new home.

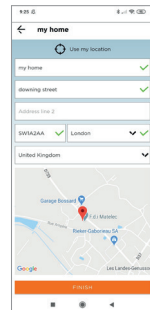

Fill in the fields and click on "finish".

To remove a home

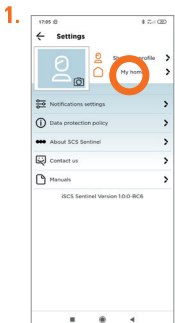

Click on  to remove a home.

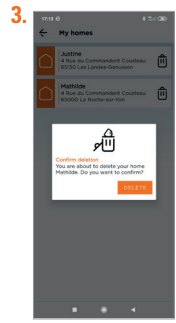

To edit a home

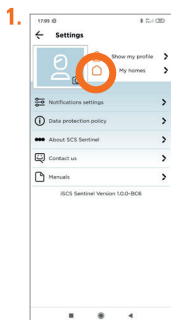

Click on 



Edit the address.

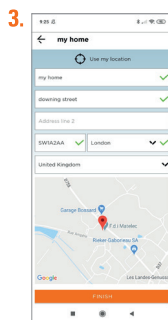

Notification settings

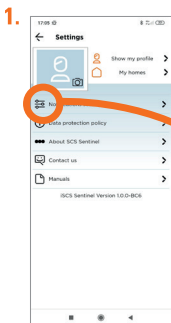

Click on  to go to the notification settings.



Click on « enable notification » to activate all notifications. Otherwise click on the desired notifications.

Using the app

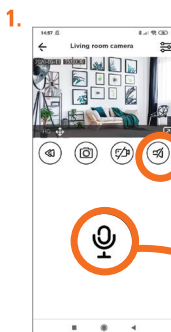

Activate listening

Click to speak



Activate full screen (tilt the phone)

Record the video on your phone.

Take a photo on your phone.

2.

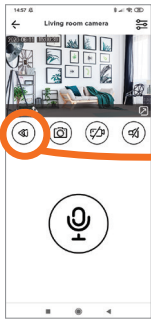

View what has happened.



Choose the date and the hour of the event to watch.

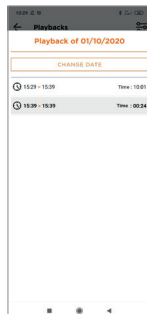

Click on «change the date» and on the required schedule to view what happened.

Save a video

Save a photo

3.

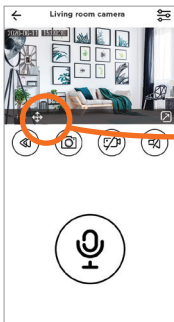

Press  to activate the joystick

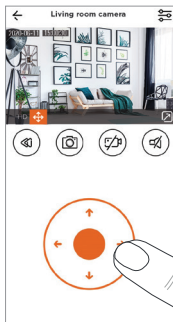

The joystick allows you to move the camera view up and down and from left to right.

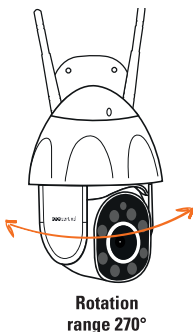
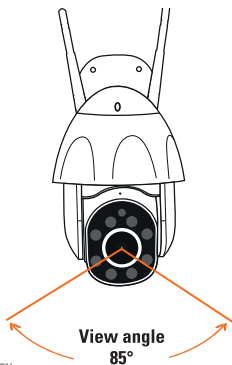

An 85° view angle and a 270° rotation angle allow you to reach a 360° view field. To do this, simply rotate the camera using the arrows from the app.

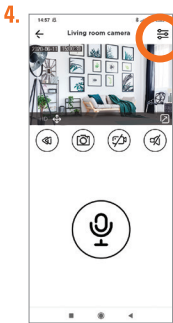

Click on  to change the camera settings.

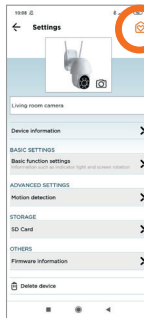

By default, the camera will appear when the app is opened in the favourites list.

Click on  to add/remove the camera from favourites.

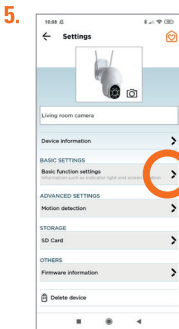

Click on basic function settings.

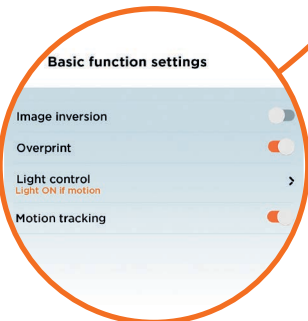
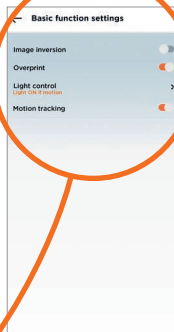

Select «**Image Inversion**» to enable image rotation when you need to position your camera upside down.

Select «**Overprint**» to display the date and time on the video.

Click on «**Light Control**» to display the different possibilities of night vision.

«**Light ON if motion**» : The camera illuminates the scene if a human form is detected

«**Light OFF**» : the camera never illuminates the scene

«**Light ON**» : the camera permanently illuminates the scene.

Select «**Motion tracking**» if you want the camera to follow the visitor's movement by pivoting.

6. Motion tracking

If you turn on «motion tracking», your camera will rotate every time a visitor will be present in its view angle.

Set the default view field to monitor (position of your camera).

Step 1 - Define an area to monitor by orienting your camera with the iSCS Sentinel app. (joystick, page 24)

Step 2 - Once the camera is facing the area to be monitored, enable motion tracking (page 25).

READY - Your camera follows the visitor's movement, once there is no more movement your camera returns to its chosen position (step 1).

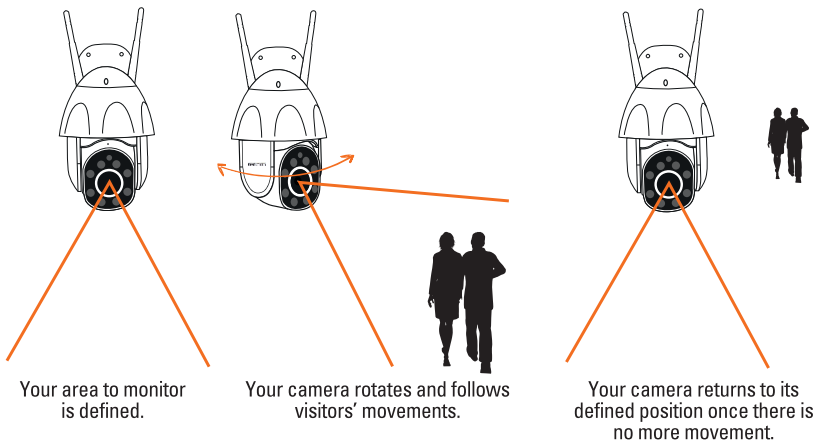

7. Viewing Motion Detection Records

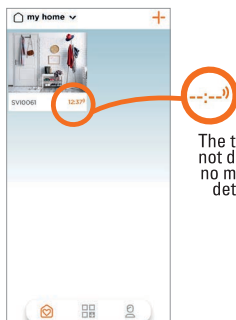

Click on the recording time of the last motion detection



Click on the video to watch the last motion detection

8.

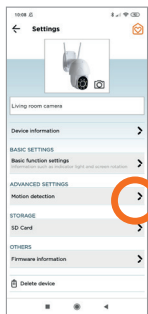

Press «Sensitivity» to manage the motion sensor. Higher is the «sensitivity», the more the camera will detect a motion.

Click on «motion detection» to program motion detection.



Select «Alarm» if you want to be notified of any movement.



Click on «Program»



Click on +

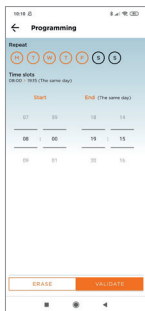

Select the desired days and time periods for motion detection, then «CONFIRM»



Your program has been added.

SD card settings (if there is an SD card installed in your camera)

1.

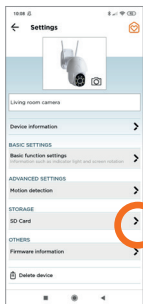

Click on «SD micro card» to access the settings.

2.

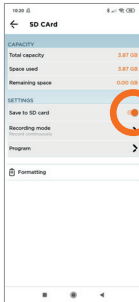

Click on «Record on SD micro card» to automatically save photos and videos on your camera's SD micro card.

3.

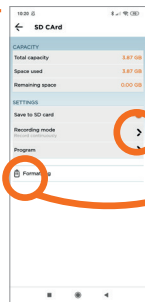

Click on
"recording mode"

Press
"Formatting"
to reset your
micro SD card.

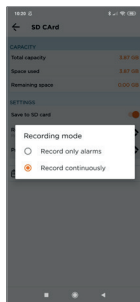

Then choose whether
to record only alarms or
continuously.

4.

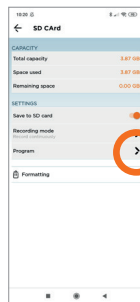

Click on "Program" to
programme the periods for
recording on the SD card.



Click on +

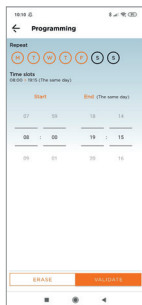

Select the desired days and time
periods for saving videos/photos, then
"CONFIRM"



Your program has
been added.

Reset

To reset the camera, press & hold the button during 5 seconds. This will remove camera pairing to your Wi-Fi network.

To completely remove the device, you will need to delete it in the app.

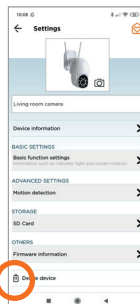
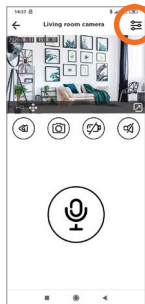
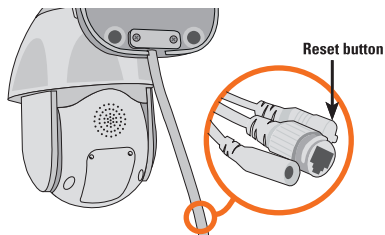

E- TECHNICAL SPECIFICATIONS

Camera

Resolution	1080p
Wi-Fi range	30 m free-field range
Compatibility	iOS, Android
Motion detection/Night vision	Yes
Memory card	SD micro from 4 to 128 Go (not supplied)
Video recording	Yes (on SD micro card)
Horizontal view angle	85°
Vertical view angle	45°
Horizontal rotation range	270°
Vertical rotation range	90°
Operating frequency	2412-2472 MHz
Max. transmit power	< 100 mW
Weather-resistant	IP 65

Adaptor

Power supply

Input : 100-240V AC 50/60Hz 0,7A
Output : 12V DC 2A

F- TECHNICAL ASSISTANCE

Troubleshooting assistance

Problem encountered	Solutions
If adding the camera fails	<ul style="list-style-type: none">- Check the power supply is properly connected.- Check that you are connected to wi-fi when entering the wi-fi password and do not include spaces.- Check that you have entered the wi-fi password correctly.- Check that your router is connected to the internet.- Make sure you have sufficient bandwidth.- Check that your smartphone is connected to the same network entered in the app.- Check that the wi-fi network you are attempting to connect to is on 2.4 GHz and not 5 GHz.- Pairing must be completed within 3 m of the wi-fi router.- Contact your internet service provider to check your router's settings (UPNP activated, MAC address filtering deactivated, SSID not hidden, DHCP activated, VPN or Proxy deactivated)

G- GARANTIE



Warranty 2 years

Keep the barcode in a safe place, along with proof of purchase these will be requested if you need to use the warranty. **It is essential to keep proof of purchase throughout the warranty period.**

Not covered by the warranty:

- Material and electrical damage resulting from incorrect installation.
- Damage resulting from improper use (other than for its intended purpose) or modifications.
- Damage resulting from the use and/or installation of parts not included or recommended by SCS Sentinel.
- Damage DUE to a lack of maintenance or impact.
- Damage RESULTING from poor weather, such as hail, lightning or strong winds.
- Returns without a copy of the invoice or proof of purchase.

H- WARNINGS



Unused equipment must not be disposed of with normal household waste. The hazardous substances it may contain could be harmful to health and the environment. Use the special collection services provided by your local authorities or distributor.



A- AVVERTENZE DI SICUREZZA

Il presente manuale costituisce parte integrante del prodotto. Queste istruzioni vengono fornite per vostra sicurezza. Siete pregati di leggerle con attenzione prima dell'uso e di conservarle per ulteriori esigenze di consultazione. L'alimentatore deve essere collocato in un luogo asciutto. Verificare che questo prodotto venga utilizzato esclusivamente per l'uso a cui è destinato.

 Il presente manuale può essere soggetto a modifiche man mano che l'applicazione viene aggiornata. Per essere sicuri di avere l'ultima versione, consigliamo di scaricarla dal nostro sito web www.scs-sentinel.com o dall'applicazione iSCS Sentinel : regolazioni / manuali.

B- DESCRIZIONE

Contenuto del kit



Telecamera
con antenna



Adattatore
elettrico



Istruzioni



Viteria



Kit di tenuta

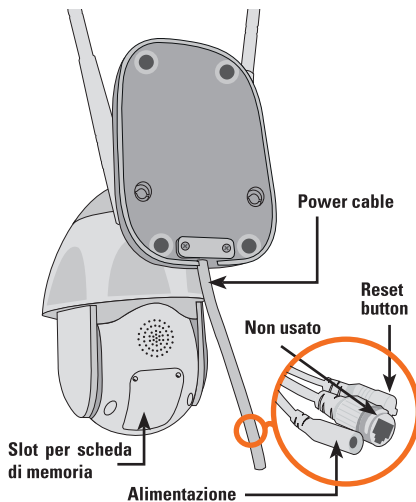
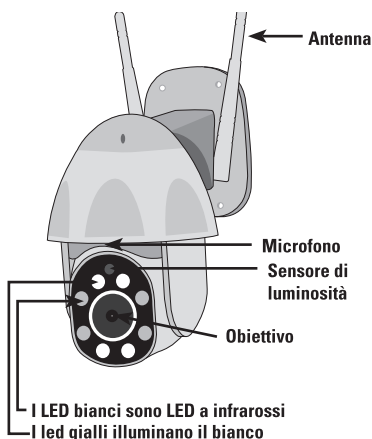

C- INSTALLAZIONE

1. Fissare la telecamera con viti e tasselli adeguati al tipo di supporto (le viti ed i tasselli in dotazione sono adatti per pareti piene).
2. Fissare saldamente la telecamera per evitare che cada.

Svitare le 3 viti sulla parte superiore della camera

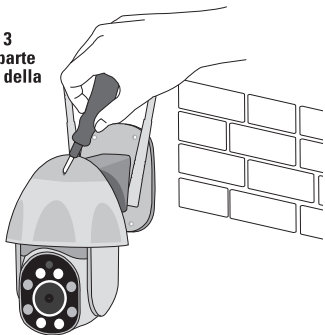

Fissare al muro



Riavvitare le 3 viti dopo aver fissato la camera al muro

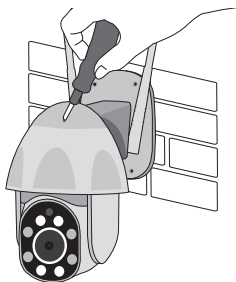

L'adattatore deve essere collegato all'interno.



È possibile inserire una scheda di memoria micro SD (da 4GB a 128GB) nella telecamera per memorizzare le sequenze video nella telecamera. **La scheda micro SD è necessaria per accedere alla cronologia video dall'applicazione.**

Svitare le due viti dalla cache

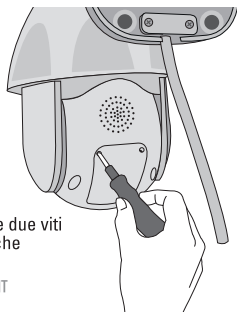

Inserisci qui la scheda micro SD, ripristina la copertura, riprova e riavvia la camera.

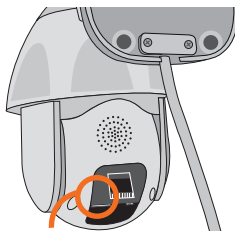

D- CONFIGURAZIONE

Installazione dell'applicazione



iSCS Sentinel

Per scaricare l'applicazione, effettuare il login da App Store o Play Store del proprio smartphone. Cercare «iSCS Sentinel», poi cliccare su Installare.

1.



Quando il download è completo, aprire l'applicazione e cliccare su « creare ».

2.



Inserire l'indirizzo e-mail e la password nelle caselle corrispondenti.

3.



Si prega di accettare l'informativa sulla privacy prima di cliccare su seguente.

Premere il tasto seguente.

4.



Compilare il codice di convalida ricevuto via e-mail. Poi confermare l'account.

5.

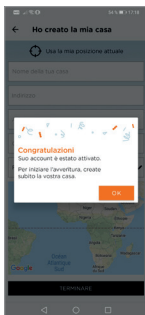

6.

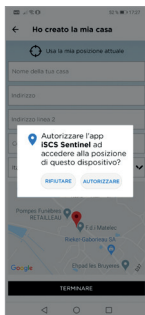

Premere AUTORIZZARE.

7.

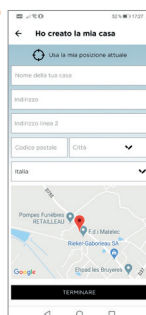

Inserire tutte le informazioni necessarie per creare la propria casa. Poi cliccare su Terminare.

Aggiunta della telecamera



WIFI

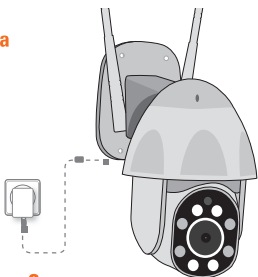

Collegare l'alimentatore della telecamera e posizionarla vicino al modem Wi-Fi. Il telefono deve essere collegato alla stessa rete Wi-Fi della telecamera. Aspettare l'annuncio vocale.



Premere + poi «NUOVO DISPOSITIVO» per aggiungere la telecamera.



La rete deve essere in 2,4 GHz per funzionare

2.4 GHz

Inserire la chiave Wi-Fi e flashare il QR Code della telecamera o inserire il codice manualmente.



Quando la telecamera annuncia « in attesa dell'impostazione », premere Segue. Se la telecamera non annuncia nulla, premere il pulsante di reset per 5s.

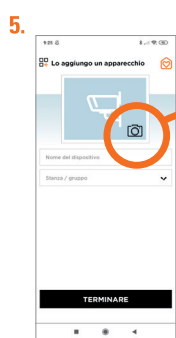

Inserire un nome per la telecamera e la stanza in cui si trova.



Aggiungere una foto del profilo dalla fotocamera, galleria o selezionare un'immagine predefinita (visuale del prodotto o ultima acquisizione del movimento.)



Se il dispositivo non riesce a connettersi al Wi-Fi, una pagina di errore appare.

Risoluzione dei problemi



Cliccando su «ripetere l'operazione»: si ritorna al 2° passo.



Se «ripetere l'operazione» non funziona, premere «altro metodo».



Premere «usa QR Code»

Controllare questi 5 punti.

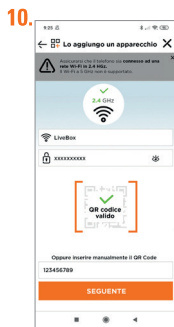

Controllare le informazioni e cliccare su seguente.



Rispettare questi 3 passi premendo «Mostra il codice QR».



Avete sentito il bip? No: Ricominciare da capo. Sì: Passo confermato



Il caricamento viene effettuato ed i 3 passaggi sono convalidati. Si ritorna ai passi 5 e 6 per modificare l'immagine del profilo.

Impostazioni



Premere  per accedere alle impostazioni dell'applicazione.

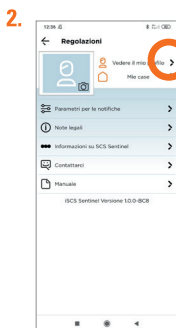

Visualizza il mio profilo:
Modificare i dati personali se necessario.

Per aggiungere una casa

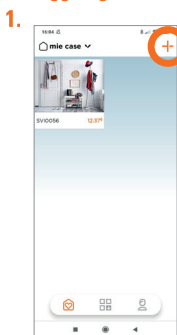

Cliccare 

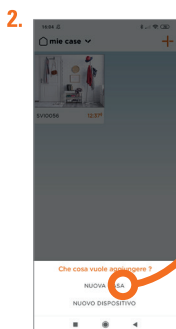

Creare una nuova casa.

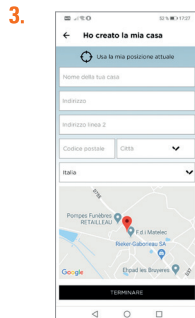



Compilare i campi e premere «TERMINARE».

Per cancellare una casa

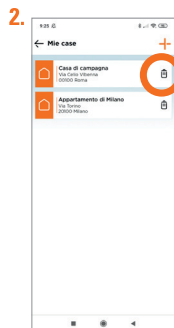

Premere 



Premere  per cancellare una casa.



Per modificare una casa

- 

1. Premere 
- 

2. Modificare l'indirizzo.
- 

3. **REGISTRARE**

Impostazioni delle notifiche

- 

1. Premere  per accedere alle impostazioni delle notifiche.
- 

2. Premere Attiva notifiche per attivare tutte le notifiche. Altrimenti, premere le notifiche desiderate.

Utilizzo dell'applicazione

- 

1. Premere per parlare.
- 

Attivare l'ascolto.

Riprendere il video nel telefono.

Riprendere la foto nel telefono.

2.

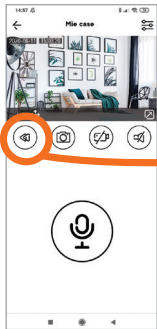

Visualizzare cosa è successo.



Scegli la data e l'ora dell'evento da visualizzare.

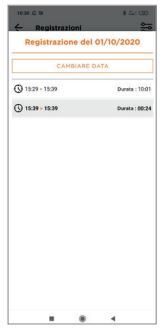

Fare clic su «cambia data» e l'orario desiderato per vedere cosa è successo».

Salvare un video

Salvare una foto

3.

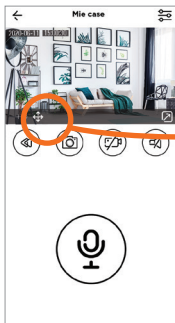

Premere per attivare il joystick

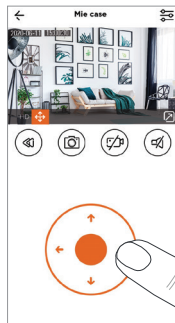

Il joystick consente di spostare la vista della camera dall'alto verso il basso e da sinistra verso destra.

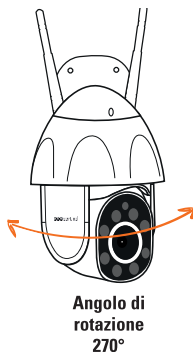
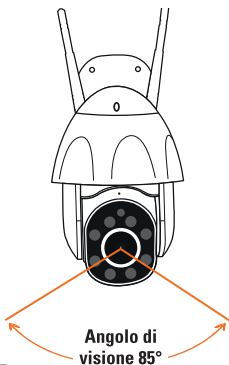

Un angolo di visione di 85° e un angolo di rotazione di 270° permettono di raggiungere un campo di visione di 360°. Per fare questo basta girare la camera con le frecce dall'app.

3.



Premere  per modificare le impostazioni della telecamera.



Di default, la telecamera apparirà nell'elenco dei preferiti non appena l'applicazione viene aperta. Premere  per aggiungere/rimuovere la telecamera dai preferiti.

4.



Premere regolazione della funzione de base



Regolazione della funzione de base

Inversione d'immagine

Sovrastampa

Controllo della luce
Luce ON se movimento >

Motion tracking

Selezionare «Inversione d'immagine» per attivare la rotazione dell'immagine quando è necessario posizionare la camera a rovescio.

Selezionare «sovrastampa» per visualizzare la data e l'ora sul video.

Fare clic su «Controllo della luce» per visualizzare le varie possibilità della visione notturna.

«Luce ON se movimento»: la camera illumina la scena se viene rilevata una forma umana

«Luce OFF»: la camera non illumina mai la scena

«Luce ON»: la camera illumina la scena in permanenza.

Selezionare «Motion Tracking» se si desidera che la camera segua il movimento del visitatore ruotando.

6. Rilevamento del movimento

Se attivate il «rilevamento del movimento», la vostra camera girerà ogni movimento di un visitatore presente nel suo angolo di visione.

Definire il campo visivo predefinito da sorvegliare (posizione della camera).

Fase 1 - Imposta prima un'area da monitorare orientando la camera con l'app iSCS Sentinel. (Joystick, pagina 38)

Fase 2 - Una volta che la camera è orientata verso l'area da monitorare, attivare il rilevamento del movimento (pagina 39).

Pronto - La camera segue il movimento del visitatore, una volta che non c'è più movimento la camera ritorna alla sua posizione scelta (punto 1).

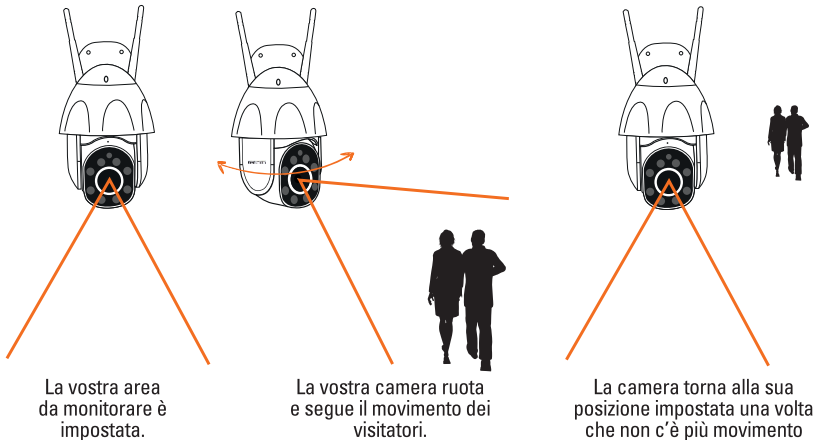

7. Visualizzazione delle registrazioni dei sensori di movimento



L'ora non verrà visualizzata se non viene rilevato alcun movimento.

Fare clic sull'ora di registrazione dell'ultimo rilevamento di movimento.

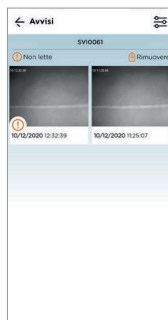

Fare clic sul video per visualizzare l'ultimo rilevamento movimento

8.



Premere «rilevamento movimento» per programmare il rilevamento di movimento.

Premere «Sensibilità» per gestire il rilevatore di movimento. Più alta è la sensibilità, più la camera rileva un movimento.



Selezionare «Allarme» se si desidera essere avvisati di un movimento.



Premere «Programmazione»



Premere +

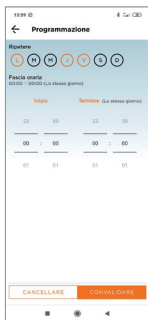

Selezionare i giorni desiderati e l'intervallo di tempo per il rilevamento di movimento e poi «CONFERMARE».

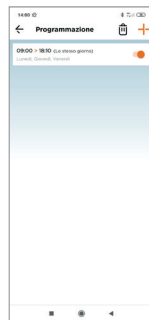

La programmazione è stata aggiunta.

Impostazioni della scheda SD (solo se presente nella telecamera)

1.



Premere «scheda micro SD» per accedere alle impostazioni.

2.

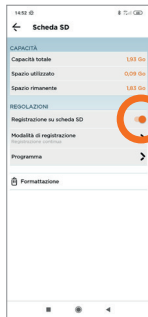

Premere «Salva su scheda micro SD» per salvare automaticamente foto e video sulla scheda micro SD della telecamera.

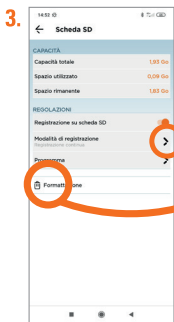

Premere «Modalità di registrazione».

Premere «Formattazione» per resettare la scheda micro SD.

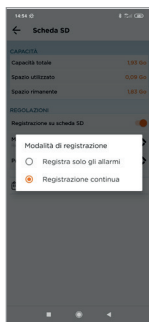

Poi scegliere di registrare solo gli allarmi o in modo continuo.

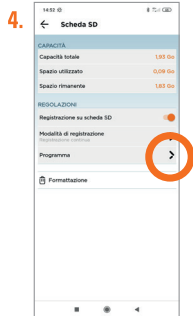

Premere «Programmare» per programmare i periodi di registrazione sulla scheda SD.



Premere +



Selezionare i giorni desiderati e l'intervallo di tempo per la registrazione video/foto e poi «CONFERMARE».

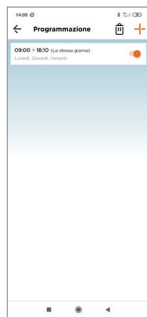

La programmazione è stata aggiunta.

Reset

Per riavviare la telecamera, tenere premuto il pulsante per 5 secondi. Questa operazione rimuoverà l'accoppiamento della telecamera alla rete Wi-Fi.

Per rimuovere completamente la telecamera, è necessario cancellarla nell'applicazione.

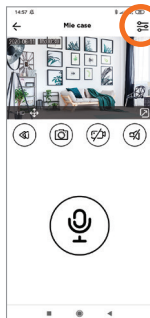
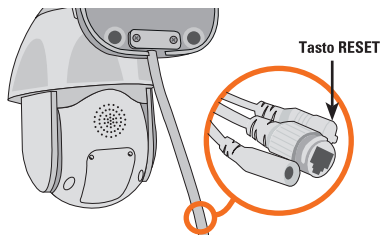

E- CARATTERISTICHE TECNICHE

Telecamera

Risoluzione	1080p
Portata Wi-Fi	30 m in campo aperto
Compatibilità	iOS, Android
Rilevamento del movimento / visione notturna	Sì
Scheda di memoria	Micro SD da 4 a 128 GB (non inclusa)
Registrazione video	Sì (su scheda microSD)
Angolo di vista orizzontale	85°
Angolo di vista verticale	45°
Angolo di rotazione orizzontale	270°
Angolo di rotazione verticale	90°
Frequenza d'esercizio	2412-2472 MHz
Potenza max. trasmessa	< 100 mW
Resistente alle intemperie	IP 65

Adattatore

Alimentazione

Ingresso : 100-240V AC 50/60Hz 0,7A
Uscita : 12V DC 2A

F- ASSISTENZA TECNICA

Assistenza per la risoluzione dei problemi

Problema riscontrato	Soluzioni
Se non si riesce ad aggiungere la telecamera	<ul style="list-style-type: none">- Controllare che l'alimentazione sia collegata correttamente.- Verificare di essere connesso in Wi-Fi- durante la digitazione della password Wi-Fi, non digitare gli spazi.- Verificare di aver inserito correttamente la password Wi-Fi.- Verificare che la connessione Internet è presente.- Assicurarsi di avere una velocità sufficiente.- Verificare che lo smartphone si trovi sulla stessa rete di quella specificata nell'applicazione.- Verificare che la rete Wi-Fi a cui si sta cercando di connettersi sia a 2,4GHz e non a 5GHz.- Fare l'accoppiamento entro 3 metri dal modem Wi-Fi.- Contattare il proprio internet provider per verificare le impostazioni del modem (UPNP abilitato, filtro indirizzo MAC disabilitato, SSID non mascherato, DHCP abilitato, VPN o Proxy disabilitato).

Assistenza telefonica

I tecnici del servizio post-vendita sono disponibili al numero :



Hotline



011-2339876

In caso di malfunzionamento del prodotto durante l'installazione o pochi giorni dopo la stessa si invita a contattare il servizio clienti rimanendo in prossimità del prodotto in modo da consentire ai nostri tecnici di diagnosticare subito l'origine del problema.

G- GARANZIA



Garanzia 2 anni

Conservare accuratamente sia il codice a barre che lo scontrino. Vi saranno richiesti per far valere la garanzia. **La prova d'acquisto deve essere conservata per l'intero periodo di garanzia.**

Non sono coperti dalla garanzia:

- Danni materiali o elettrici derivanti da un'installazione non corretta.
- Danni derivanti da un uso improprio (uso diverso da quello descritto) o da modifiche.
- Danni derivanti dall'uso e/o dall'installazione di parti che non provengono da quelle previste e incluse da SCS Sentinel.
- Danni DOVUTI alla mancanza di manutenzione o ad un impatto.
- Danni DOVUTI a maltempo come grandine, fulmini, venti forti, ecc.
- Resa senza una copia della fattura o della prova d'acquisto.

H- AVVERTENZE



Non gettare gli apparecchi fuori uso insieme ai normali rifiuti domestici. Potrebbero contenere sostanze pericolose nocive per la salute e l'ambiente. Usare i mezzi per la raccolta differenziata messi a disposizione dal comune o dal proprio distributore



A- INDICACIONES DE SEGURIDAD

Este manual forma parte integral de su producto. Estas instrucciones son para su seguridad. Léalas atentamente antes de usar el producto y guárdelas para futuras consultas. La fuente de alimentación debe instalarse en un lugar seco. Asegúrese de que este producto se utiliza únicamente para el fin previsto.

 Este manual puede estar sujeto a cambios en función de las actualizaciones de la aplicación. Para asegurarse de que tiene la última versión, le aconsejamos que la descargue de nuestro sitio web www.scs-sentinel.com o de la aplicación iSCS Sentinel : ajustes / manuales.

B- DESCRIPCIÓN

Contenido del kit



Cámara con antena integrada



Adaptador eléctrico



Instrucciones



Tornillos



Kit de impermeabilidad

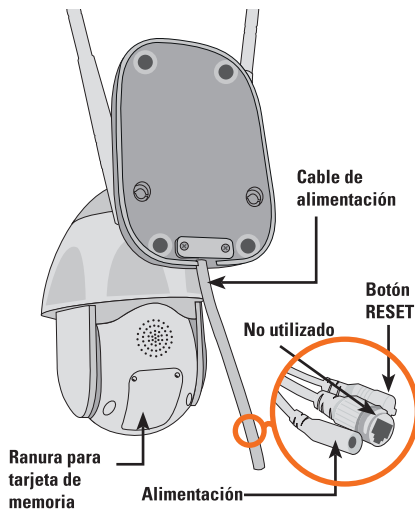
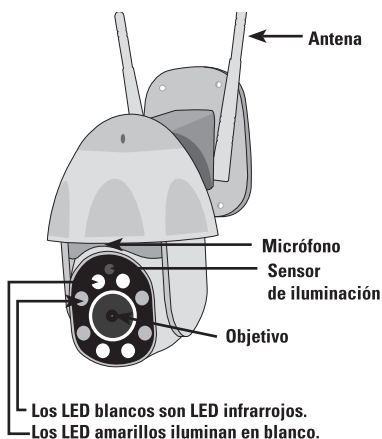

C- INSTALACIÓN

1. Fijar la cámara usando los tornillos y tacos adecuados en función del tipo de soporte (los tornillos y tacos suministrados son aptos para paredes sólidas).
2. Asegúrese de fijar bien la cámara para evitar cualquier caída.

Desenrosque los 3 tornillos de la parte superior de la cámara

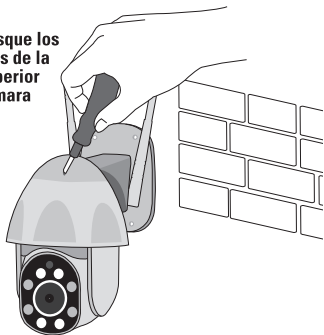

Fije en la pared

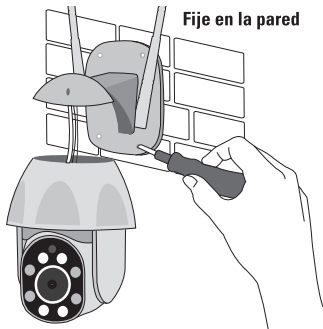

Revise los 3 tornillos después de fijar la cámara a la pared

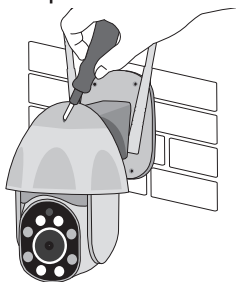

El adaptador debe enchufarse en el interior



Puede insertar una tarjeta de memoria micro SD (de 4 GB a 128 GB) para almacenar secuencias de vídeo en la cámara. **La tarjeta micro SD es necesaria para acceder al historial de vídeos de la aplicación.**

Desenrosque los dos tornillos de la tapa.

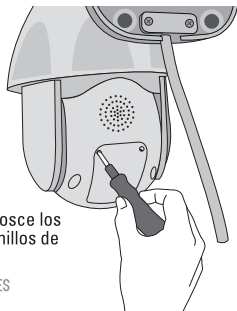

Introduzca aquí la tarjeta micro SD, vuelva a colocar la cubierta, enrosque de nuevo y reinicie la cámara.

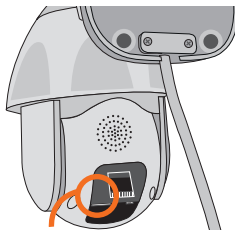

D- CONFIGURACIÓN

Instalación de la aplicación



iSCS Sentinel

Para descargar la aplicación, entre en la App Store o en el Play Store desde su smartphone. Busque «iSCS Sentinel», y luego haga clic en instalar.

1.



Quando la descarga esté completa, abra la aplicación y haga clic en crear mi cuenta.

2.



Introduzca su dirección de correo electrónico y su contraseña en las casillas correspondientes.

3.

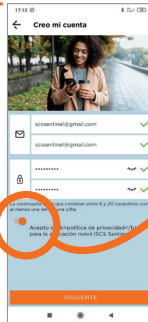

Pulse siguiente.



Por favor, acepte la política de privacidad antes de hacer clic en siguiente

4.



Introduzca el código de validación que ha recibido por correo electrónico. Luego, valide la cuenta.

5.



6.

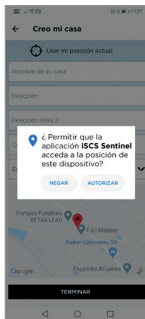

Pulse AUTORIZAR.

7.

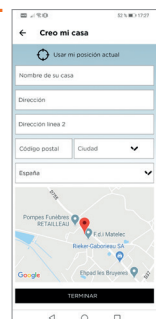

Introduzca toda la información necesaria para crear su casa. Luego, haga clic en terminar.

Añadir la cámara



WIFI

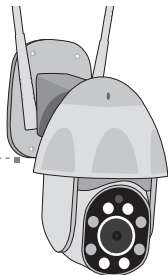

Enchufe la fuente de alimentación de la cámara y colóquela cerca de su router wifi. El teléfono debe estar conectado a la misma red wifi que la cámara. Espere la indicación de voz.



Pulse + y luego «NUEVO DISPOSITIVO» para añadir la cámara.

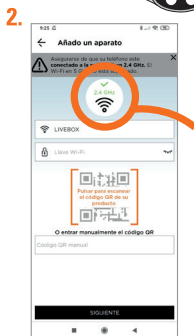

Introduzca la clave de su wifi y capture el código QR de su cámara o introduzca el código manualmente.



La red debe estar en 2,4 GHz para que funcione.



2.4 GHz



Cuando la cámara indique «A la espera de configuración», pulse siguiente. Si la cámara no indica nada, pulse el botón de reinicio durante 5 segundos.

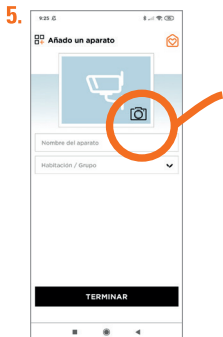

Póngale un nombre a la cámara y a la habitación en la que está.

Agregue una foto de perfil de la cámara, galería o seleccione una imagen predeterminada (visual del producto o última captura de movimiento.)

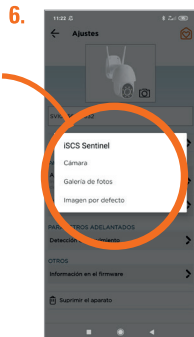



Si el dispositivo no se conecta a la red wifi, aparecerá una página de error.

Resolución en caso de fallo

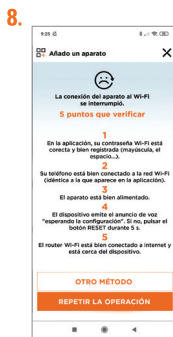

Haga clic en «Repetir la operación»: volverá al paso 2



Si «Repetir la operación» no funciona, pulse «Otro método»



Pulse «utilizar QR Code»

Compruebe estos 5 puntos.

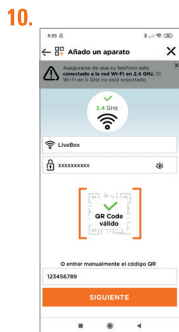

Compruebe la información y haga clic en siguiente.



Respete estos 3 pasos y pulse «Mostrar código QR».



¿Ha escuchado la señal sonora? No: empiece de nuevo. Sí: paso validado.



La carga se ha efectuado y los 3 pasos se han validado. Esto le devolverá a los pasos 5 y 6 para cambiar la foto de perfil.

Ajustes de la aplicación

1.



Pulse  para acceder a los ajustes de la aplicación.

2.



Ver mi perfil:
Si lo desea, puede modificar su información personal.

Para añadir una casa

1.



Haga clic 

2.

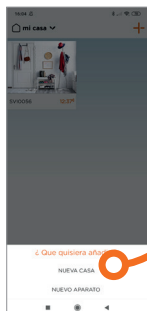

Crear una nueva casa.

3.

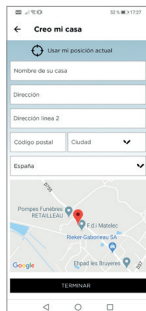

Rellene los campos y pulse Terminar.

Para eliminar una casa

1.



Pulse 

2.

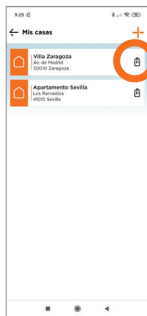

Pulse  para eliminar una casa.

3.



Para modificar una casa



- 

Pulse 
- 

Modificar la dirección.
- 

Configuración de las notificaciones

- 

Pulse  para acceder a la configuración de las notificaciones.
- 

Pulse «Activar notificaciones» para activar todas las notificaciones. De lo contrario, pulse solo las notificaciones que desea recibir.

Uso de la aplicación

- 

Pulse para hablar.

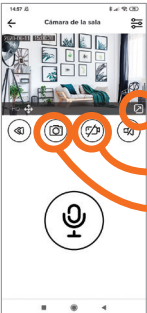

Active la pantalla completa (girar el teléfono).

Captura de video en su teléfono.

Captura de fotografías en su teléfono.

2.

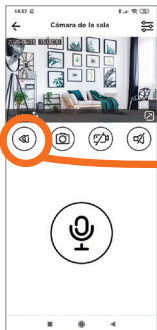

Vea lo que ha pasado.



Seleccione la fecha y la hora del evento que desea ver.

Grabe un video

Guarde una foto

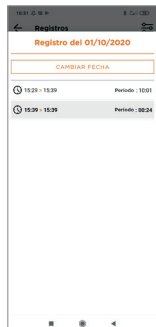

Haga clic en «cambiar la fecha» y en el horario deseado para ver lo que ha pasado»

3.

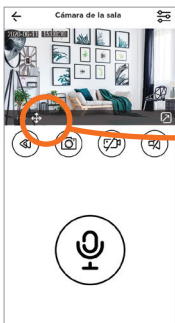

Pulse  para activar el joystick

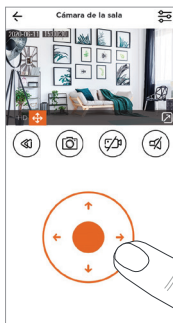

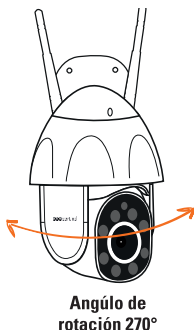
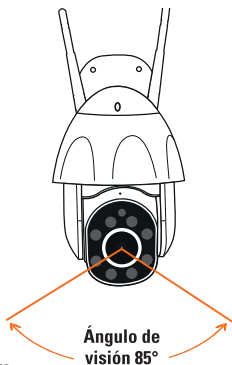

El joystick permite mover la vista de la cámara de arriba abajo y de izquierda a derecha.

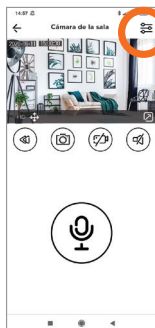

Un ángulo de visión de 85° y un ángulo de rotación de 270° permiten alcanzar un campo de visión de 360°. Para eso, basta con girar la cámara con las flechas desde la aplicación.

4.



Pulse  para modificar la configuración de la cámara.



Por defecto, la cámara aparecerá en la lista de favoritos al abrir la aplicación.

Pulse  para agregar/eliminar la cámara de los favoritos.

5.



Pulse en los ajustes de función básica.

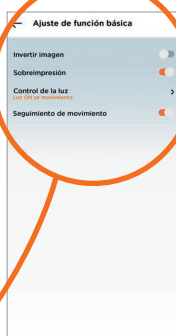

Ajuste de función básica

Invertir imagen

Sobreimpresión

Control de la luz

Luz ON si movimiento

Seguimiento de movimiento

Seleccione «Invertir imagen» para activar la rotación de la imagen cuando tenga que colocar la cámara al revés.

Seleccione «sobreimpresión» para mostrar la fecha y la hora en el video.

Haga clic en «Control de la luz» para ver las diferentes posibilidades de la visión nocturna.

«Luz ON si movimiento»: la cámara ilumina la escena si se detecta una forma humana

«Luz OFF»: la cámara nunca ilumina la escena

«Luz ON»: la cámara ilumina la escena permanentemente.

Seleccione «Seguimiento de movimiento» si desea que la cámara siga el movimiento del visitante girando.

6. Seguimiento de movimiento

Si activa el «seguimiento de movimiento», la cámara girará cada vez que un visitante se mueva desde su ángulo de visión.

Establezca el campo de visión predeterminado que desea supervisar (posición de la cámara).

Etapa 1 - En primer lugar, defina un área que debe vigilarse orientando la cámara con la aplicación iSCS Sentinel. (joystick, página 52)

Etapa 2 - Una vez que la cámara esté orientada hacia el área a vigilar, active el seguimiento de movimiento (página 53).

LISTO – La cámara sigue el movimiento del visitante, una vez que no hay movimiento, la cámara vuelve a su posición elegida (etapa 1).

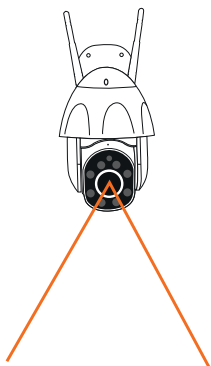

Su área de vigilancia está definida.

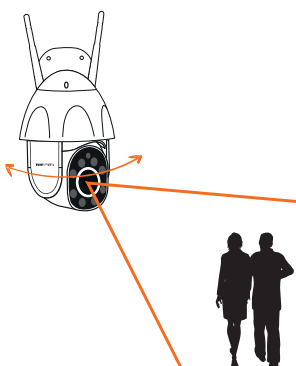

Su cámara gira y sigue el movimiento de los visitantes.

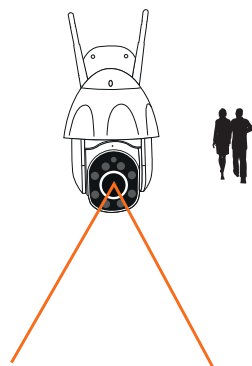

Su cámara vuelve a su posición definida una vez que no hay movimiento.

7. Visualización de los registros de detección de movimiento



La hora no aparecerá si no hay movimiento.

Haga clic en la hora de registro de la última detección de movimiento.

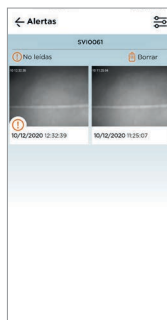

Haga clic en el vídeo para ver la última detección de movimiento



Pulse «Sensibilidad» para gestionar el detector de movimiento. Cuanto más alta es la sensibilidad, más movimiento detecta la cámara.

Pulse «Detección de movimiento» para programar la detección de movimientos

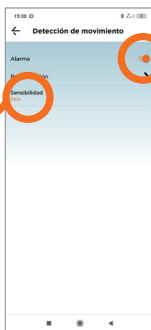

Seleccione «Alarma» si desea recibir una alerta en caso de movimiento.

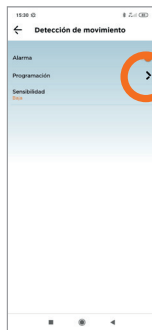

Pulse «Programación»



Pulse +



Seleccione los días y la franja horaria deseada para la detección de movimientos y luego pulse «VALIDAR»



Su programación se ha añadido correctamente.

Configuración de la tarjeta SD (solo si tiene una en su cámara)



Pulse «Tarjeta micro SD» para acceder a los ajustes.

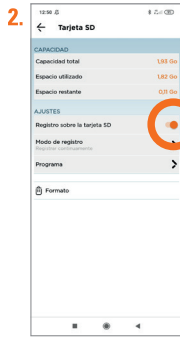

Pulse «Guardar en la tarjeta micro SD» para guardar automáticamente las fotografías y los videos en la tarjeta micro SD de la cámara.

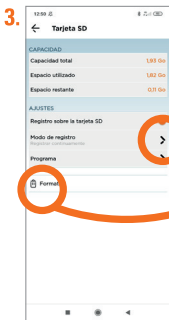

Pulse «Modo de registro».

Pulse «Formato» para reiniciar la tarjeta micro SD.

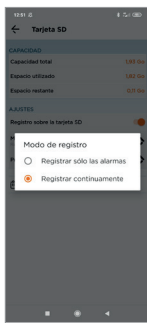

Luego, seleccione grabar solo las alarmas o de forma continua.

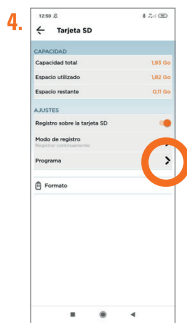

Pulse «Programar» para programar los períodos de grabación en la tarjeta SD.



Pulse +



Seleccione los días y la franja horaria deseada para la grabación de videos/fotografías y luego pulse «VALIDAR»

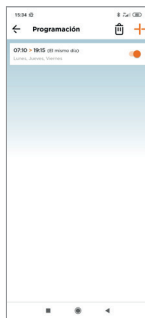

Su programación se ha añadido correctamente.

Reiniciar

Para restablecer la cámara, mantenga pulsado el botón durante 5 segundos. Esta operación eliminará el emparejamiento de la cámara a su red Wi-Fi.

Para eliminar el dispositivo por completo, hay que eliminarlo en la aplicación.

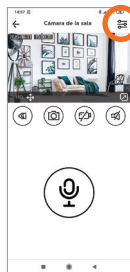
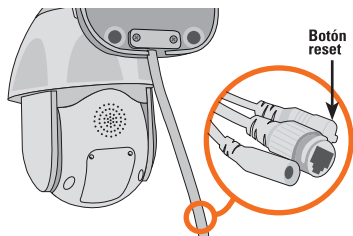

E- CARACTERÍSTICAS TÉCNICAS

Caméra

Resolución	1080p
Alcance Wi-Fi	30 m en campo libre
Compatibilidad	iOS, Android
Detección de movimientos / Visión nocturna	Si
Tarjeta de memoria	Micro SD de 4 a 128 Go (no suministrada)
Grabación de vídeo	Si (en tarjeta micro SD)
Ángulo de visión horizontal	85°
Ángulo de visión vertical	45°
Ángulo de rotación horizontal	270°
Ángulo de rotación vertical	90°
Frecuencia de funcionamiento	2412-2472 MHz
Máxima potencia de transmisión	< 100 mW
Resistente a la intemperie	IP 65

Adaptador

Alimentación

Entrada : 100-240V AC 50/60Hz 0,7A

Salida : 12V DC 2A

F- ASISTENCIA TÉCNICA

Asistencia para la resolución de problemas

Problemas	Soluciones
Si al agregar la cámara se produce un fallo	<ul style="list-style-type: none">- Compruebe que la fuente de alimentación esté bien conectada.- Compruebe que está conectado a la red wifi.- Cuando introduzca la contraseña de la red wifi, introducir sin espacios.- Compruebe que ha introducido correctamente la contraseña de la red wifi.- Compruebe que su rúter está conectado a Internet.- Asegúrese de que tiene suficiente velocidad.- Compruebe que su smartphone está en la misma red que la especificada en la aplicación.- Compruebe que la red wifi a la que intenta conectarse es de 2,4 GHz y no de 5 GHz.- Realizar el emparejamiento a menos de 3 m del rúter wifi.- Contacte con su proveedor de servicios de Internet para comprobar la configuración de su rúter (UPNP activado, filtro de direcciones MAC desactivado, SSID no enmascarado, DHCP activado, VPN o Proxy desactivado).

Asistencia telefónica

Se puede contactar los técnicos del servicio posventa a la siguiente dirección de email :

asistencia.tecnica@scs-sentinel.com

G- GARANTÍA



Garantía 2 años

Guarde en un lugar seguro el código de barras y su justificante 2 años de garantía de compra, se le pedirá para poder solicitar la garantía.

Es imprescindible conservar una prueba de compra durante todo el período de garantía.

La garantía no cubre:

- Daños materiales o eléctricos derivados de una instalación incorrecta.
- Daños derivados de un uso inadecuado (uso distinto al original) o de modificaciones.
- Daños resultantes del uso y/o instalación de piezas distintas a las previstas e incluidas por SCS Sentinel.
- Daños DEBIDOS a la falta de mantenimiento o caídas.
- Daños DEBIDOS a la intemperie, como granizo, rayos, vientos fuertes, etc.
- Devolución de artículos sin copia de la factura o justificante de compra.

H- ADVERTENCIAS



No tire los aparatos que no utilice junto con los residuos domésticos. Las sustancias peligrosas que podrían contener pueden ser perjudiciales para la salud y para el medio ambiente. Utilice los medios de recogida selectiva ofrecidos por su ayuntamiento o distribuidor.



Toutes les infos sur :
www.scs-sentinel.com



SCS sentinel

Route de St Symphorien
85130 Les Landes Génusson
FRANCE