

A710P - Remorque pour vélo

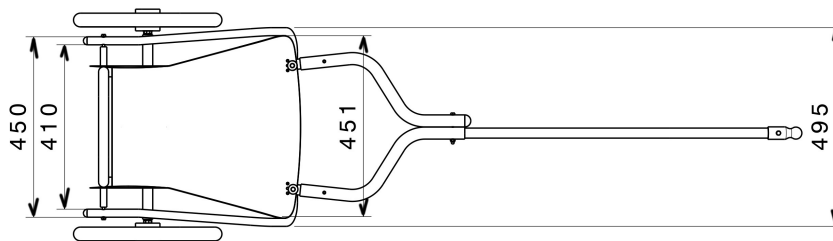

Conception et fabrication française

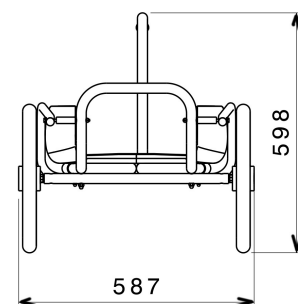
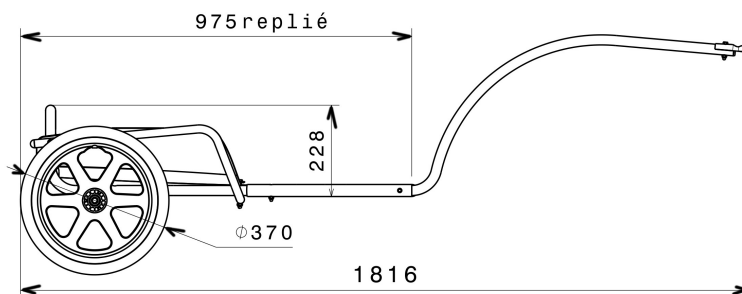
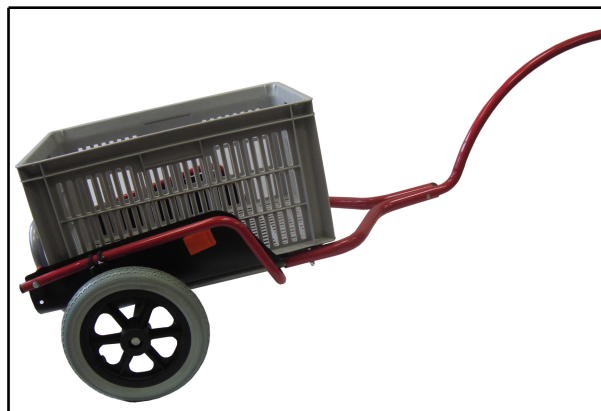
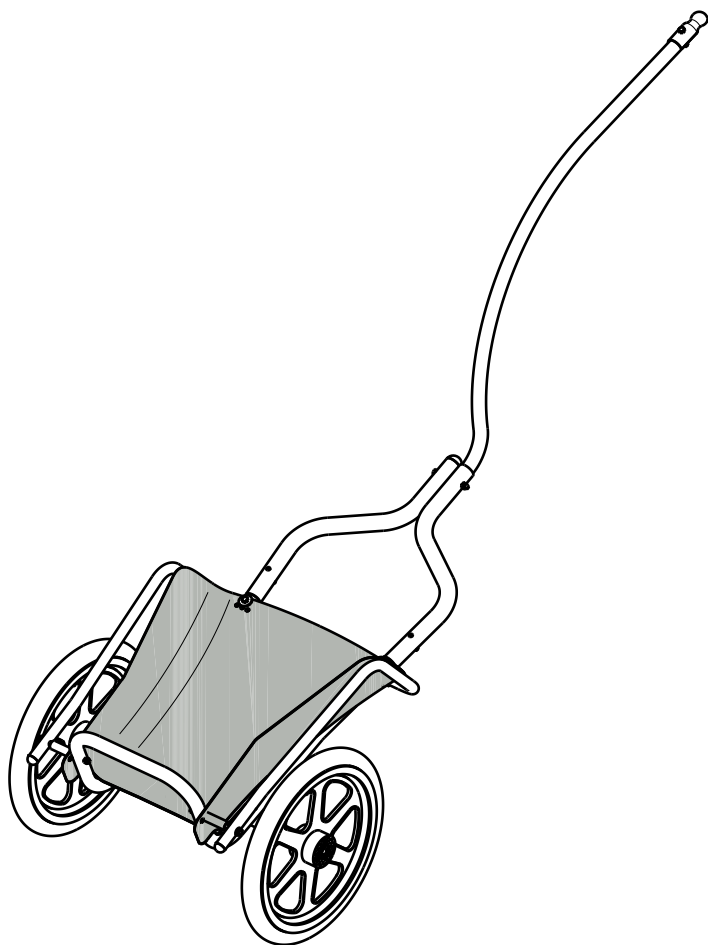

SAV



Si malgré toutes les précautions prises lors de la conception du produit, vous deviez rencontrer un problème, notre Service Après Vente reste à votre disposition. Du lundi au jeudi : de 8h00 à 17h00 et le vendredi de 8h00 à 15h00



33 (0)3 20 10 90 25



be-sav@mottez.com













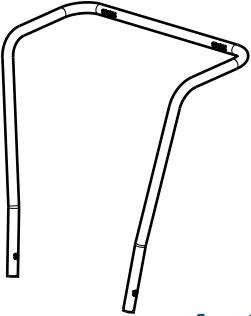
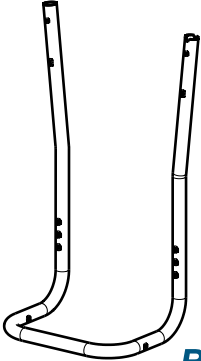
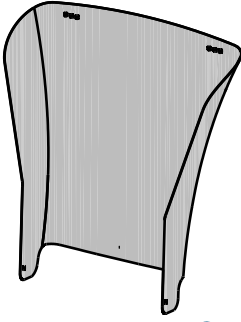
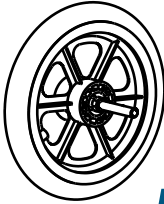
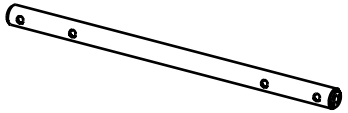

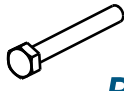





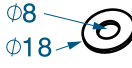



33 (0)3 20 10 37 89

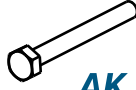
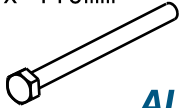

<http://www.chariotderandonnee.com>

CONA710P 19038

Lire impérativement la notice avant toute utilisation

 A x1		 B x1		 C x1		 F x2		 G x1	
 J x2		 P x2		 R x2		 T x2		 U x6	
 V x2		 W x2		 X x6		 Y x2			
 AA x2		 AB x1		 AC x2		 AD x1		 AE x1	
 AF x1		 AG x1		 AH x2		 AI x1		 AJ x2	
 AK x1		 AL x2		 AM x2		 AN x2		 AO x1	
		 AP x1							

1/. Montage de l'essieu

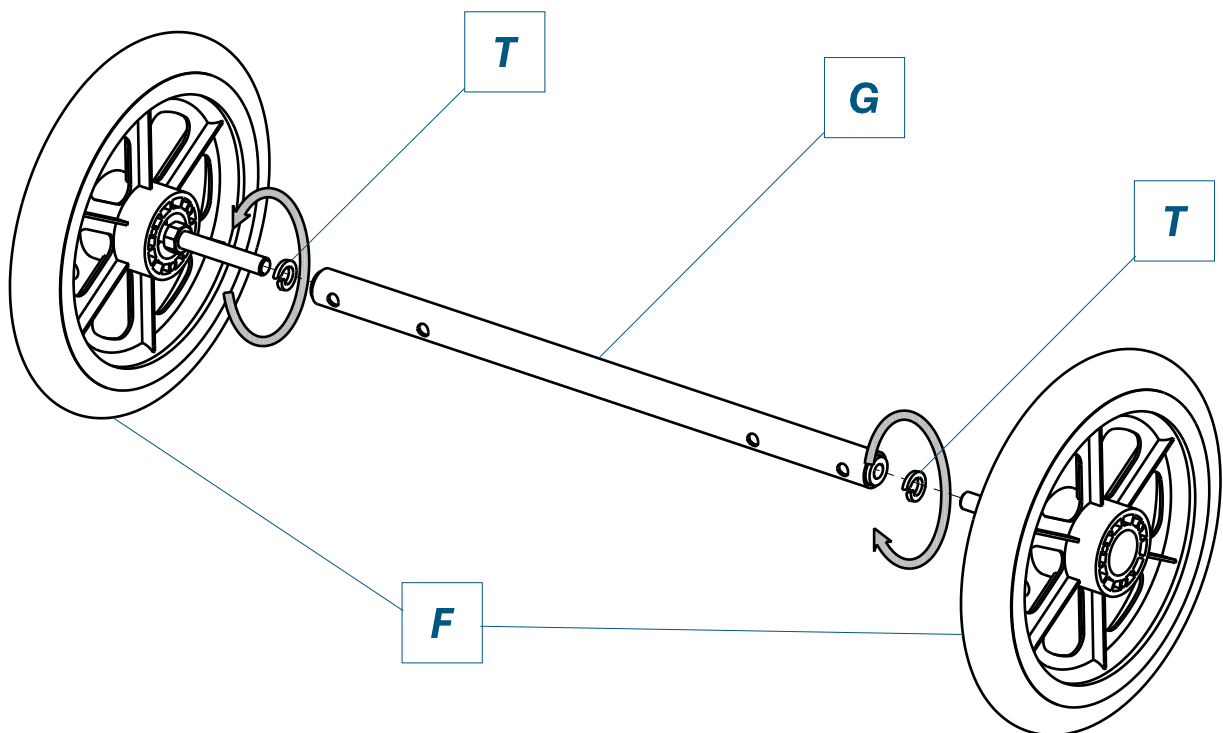

Bloquer fortement

2/. Montage de l'armature

3 positions pour avoir un écart entre les bras plus ou moins important

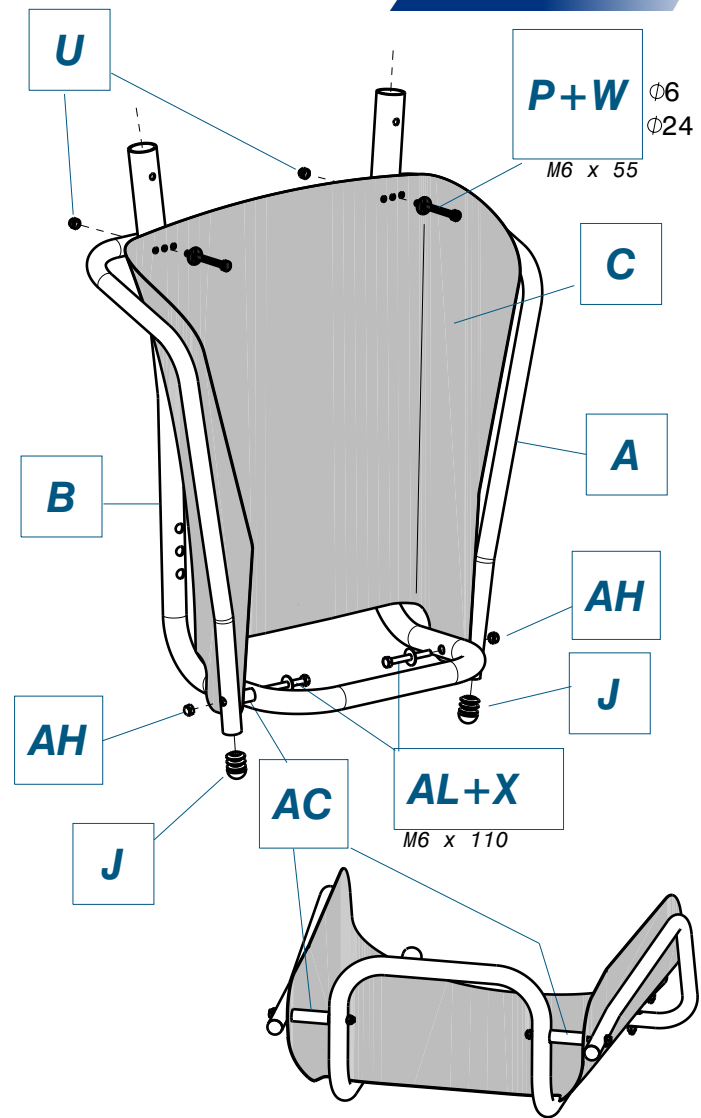
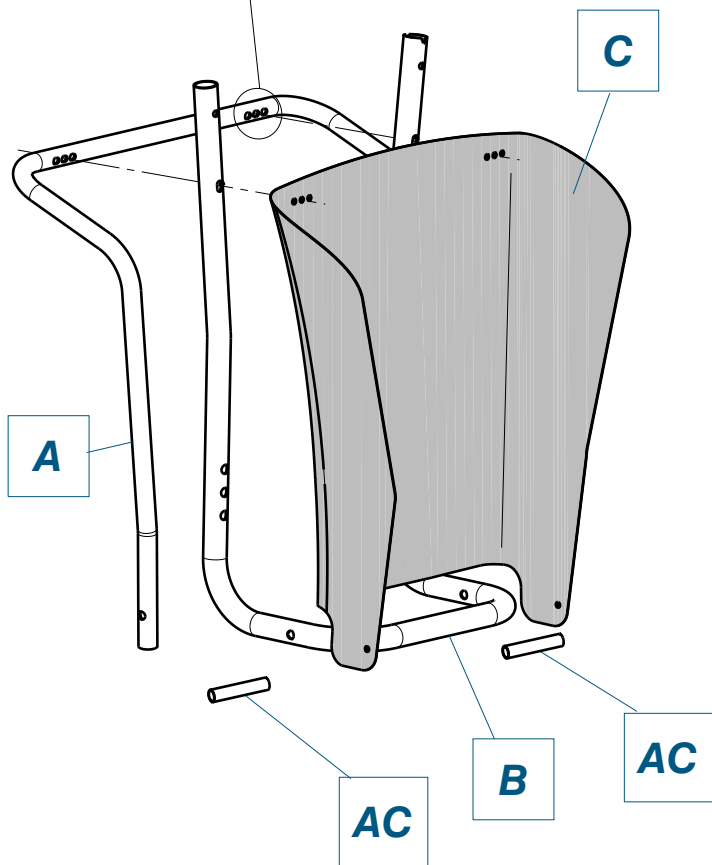

3/. Montage de l'armature sur l'essieu

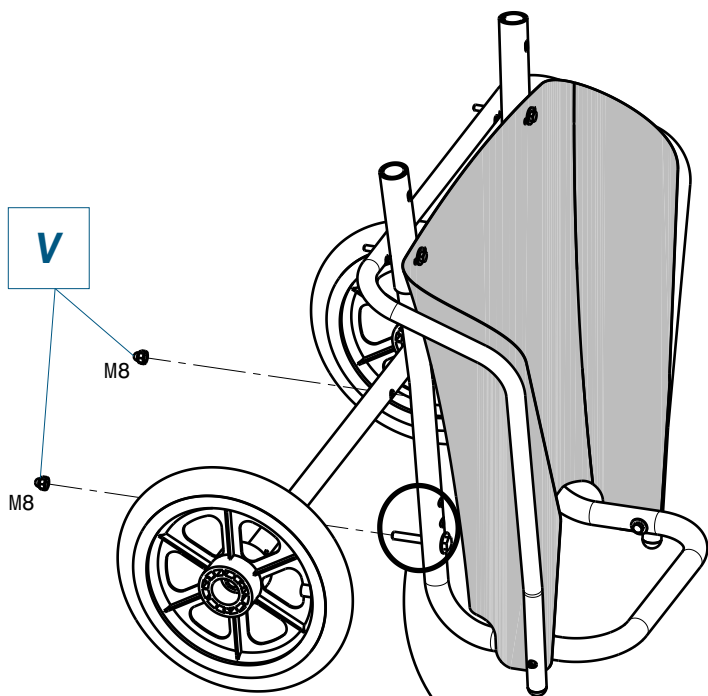

3 positions possibles à adapter en fonction de la charge. Veuillez positionner l'essieu comme ci-dessous pour la charge maxi.

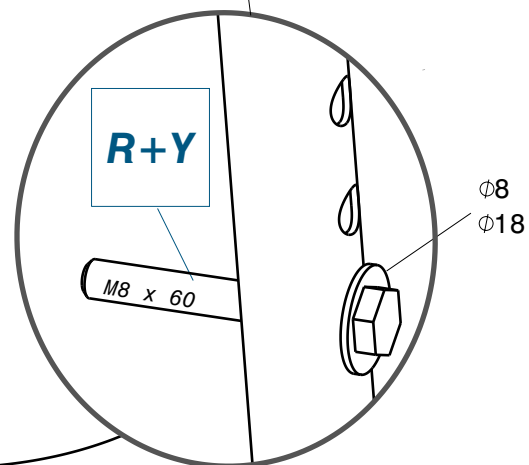

4/. Montage de l'armature supérieure

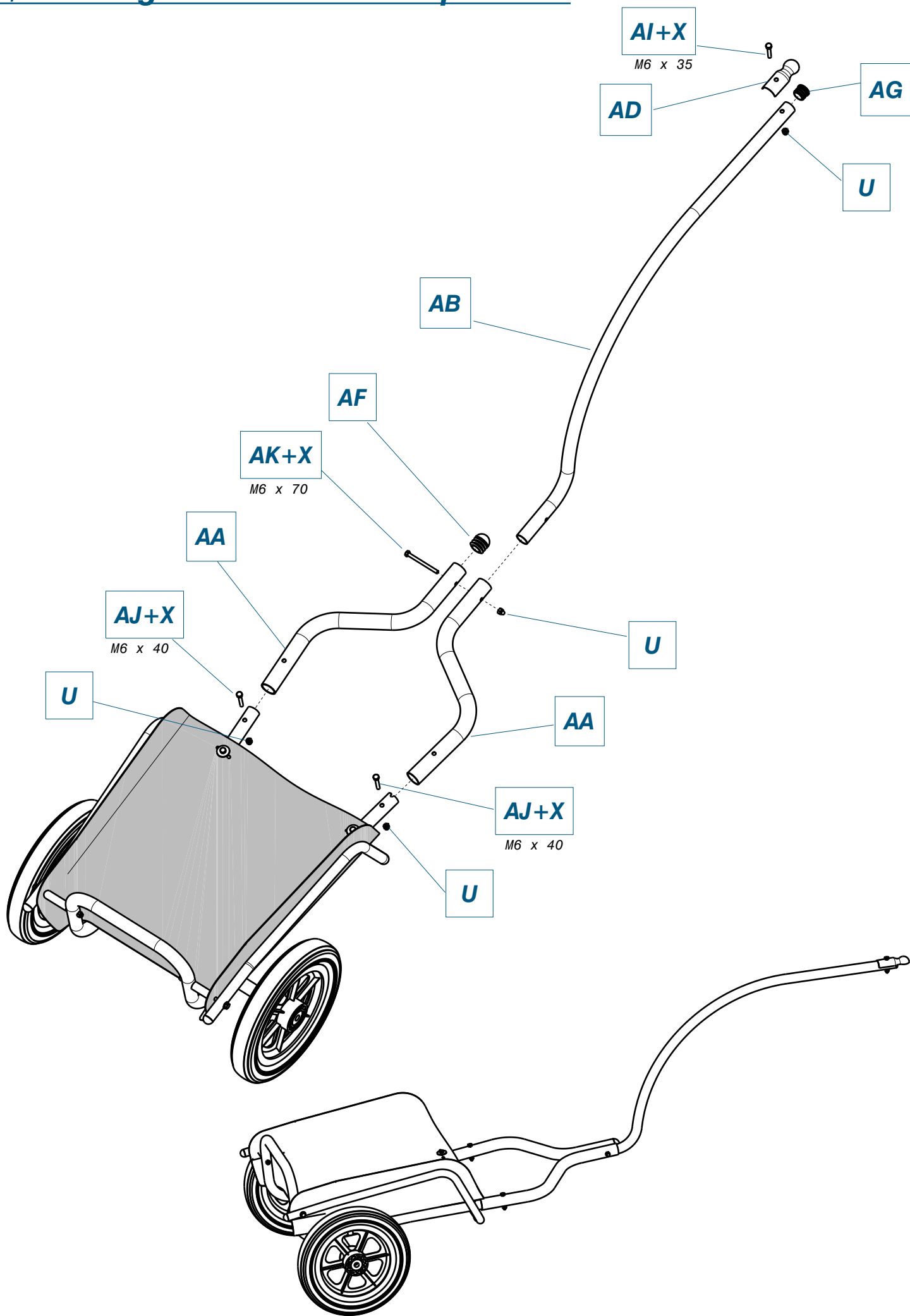

5/. Montage du produit sur le vélo

MOTTEZ



6/. Fixation des sandows

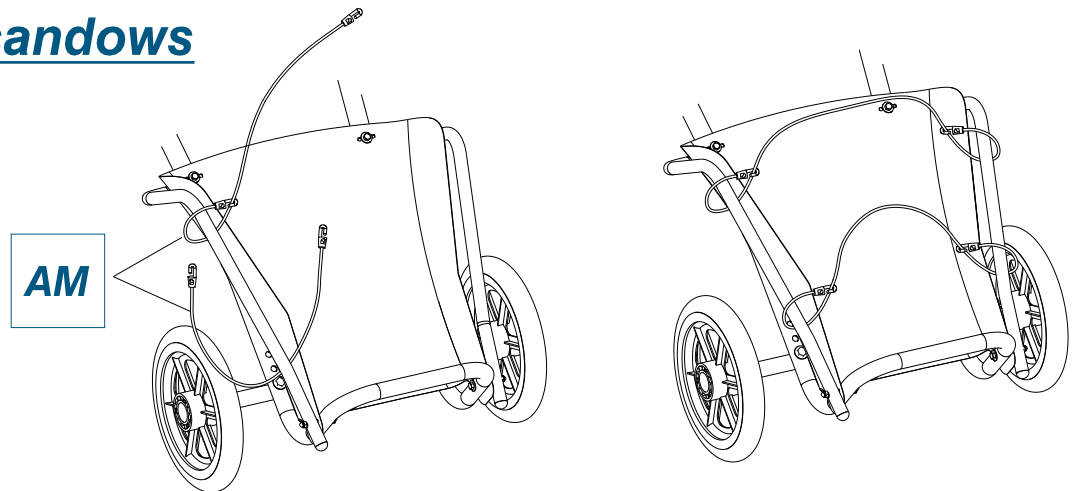

7/. utilisation du produit



A n'utiliser que de jour. La nuit, équiper le produit d'un dispositif d'éclairage rouge à l'arrière.

30 kg
maxi.

AN
catadioptrés x 2